

# COLOR THE PARADE ELEPHANT

LEVEL: EASY

ESTIMATED TIME: 30 MINUTES

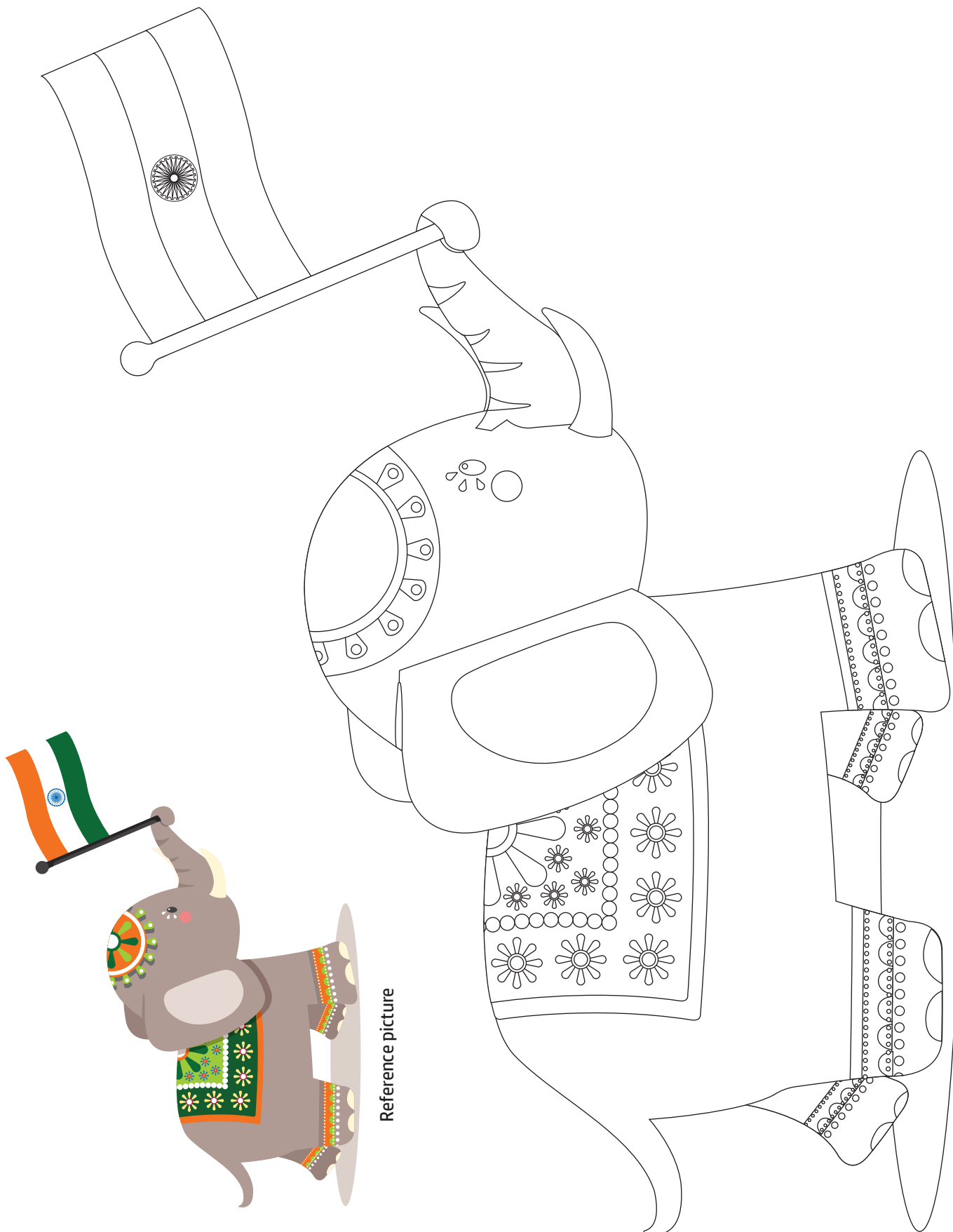

# TRACE & COLOR THE CELEBRATION BALLOONS

LEVEL: EASY

ESTIMATED TIME: 20 MINUTES



# COLOR THE HOT AIR BALLOON

LEVEL: EASY

ESTIMATED TIME: 20 MINUTES



Reference picture

# TRACE & COLOR THE INDIAN MONUMENT

LEVEL: HIGH

ESTIMATED TIME: 30 MINUTES



HAPPY  
REPUBLIC  
DAY

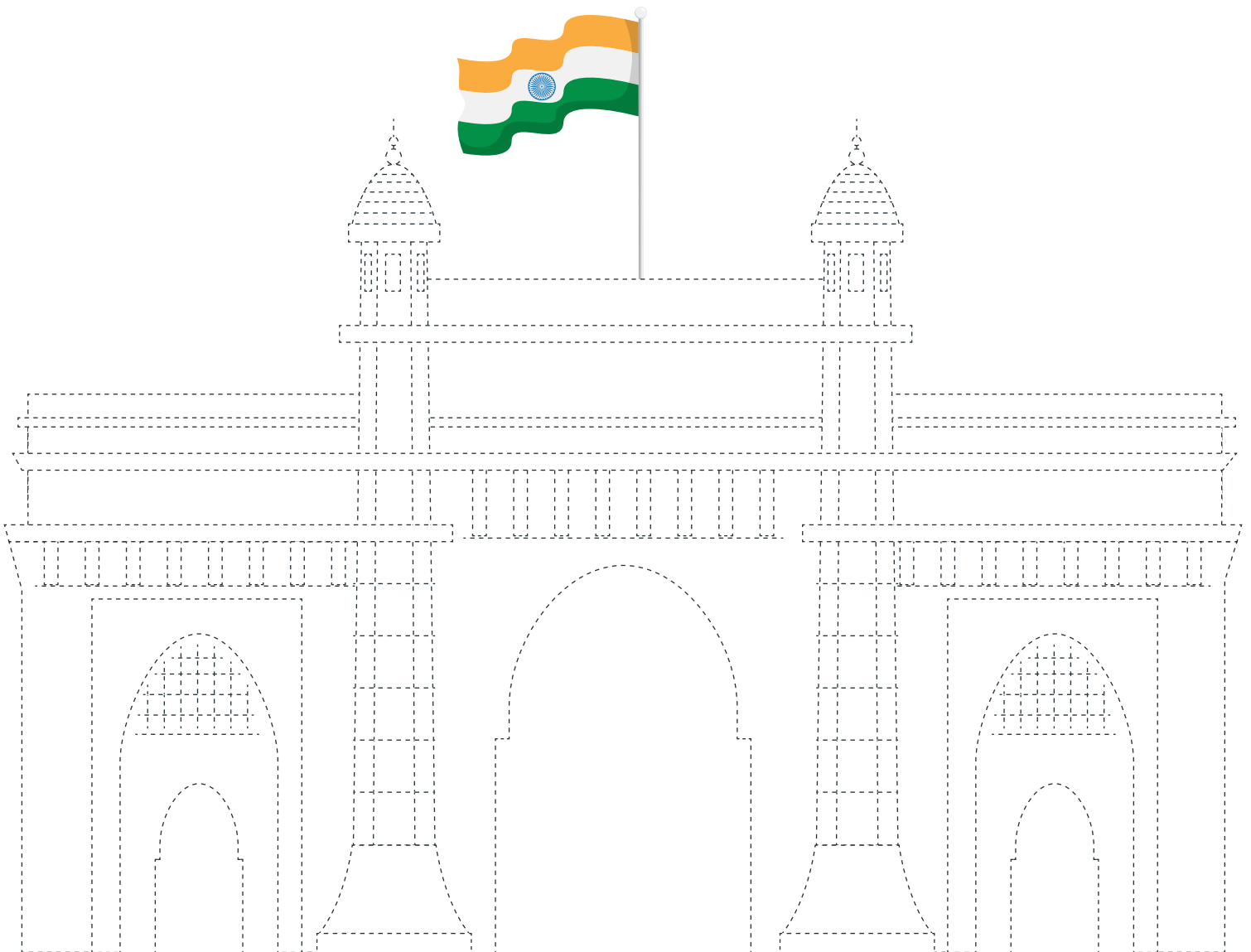

# TRACE & COLOR INDIA GATE

LEVEL: MEDIUM

ESTIMATED TIME: 20 MINUTES

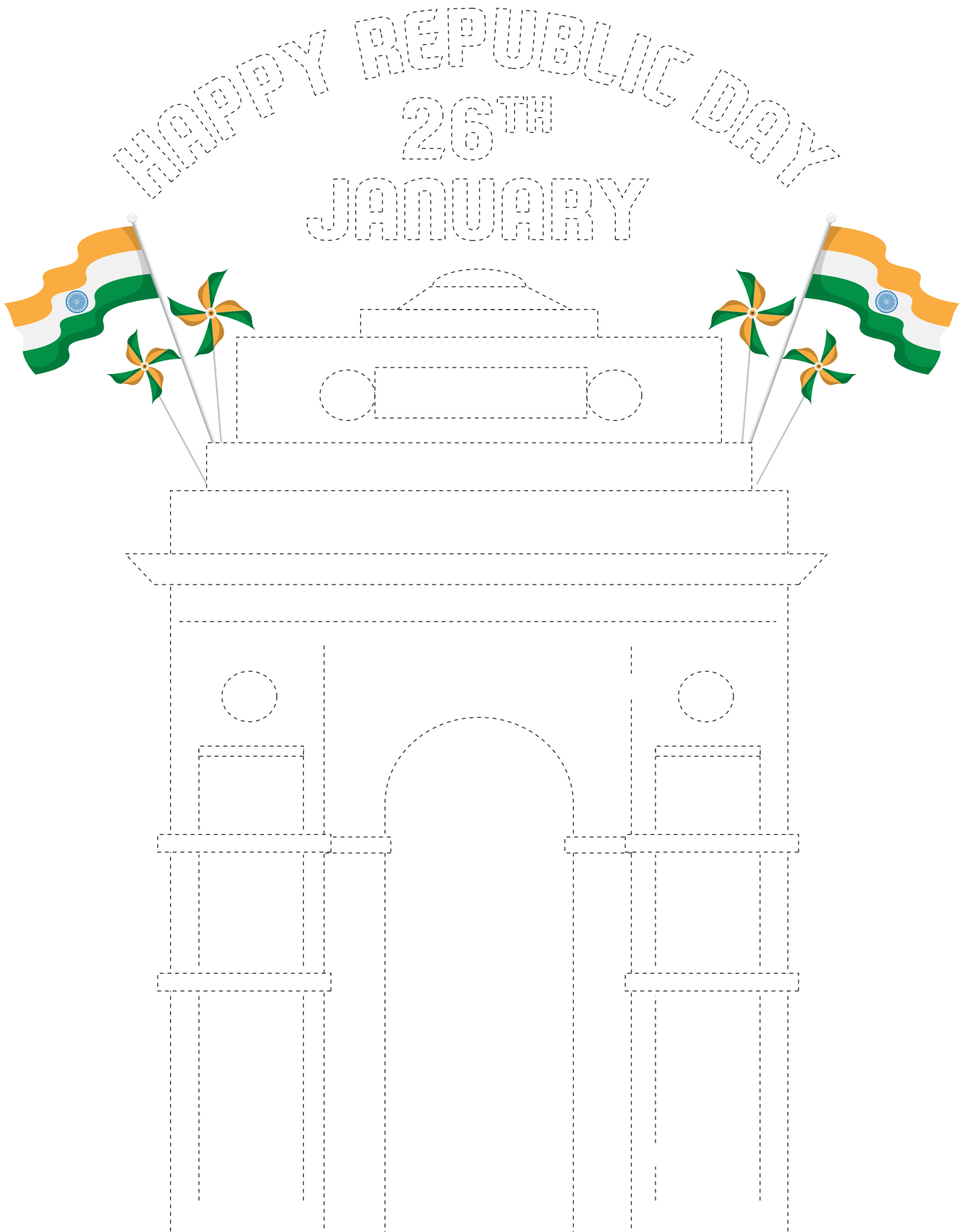

# MAKE YOUR OWN REPUBLIC DAY CARD

LEVEL: MEDIUM

ESTIMATED TIME: 20 MINUTES

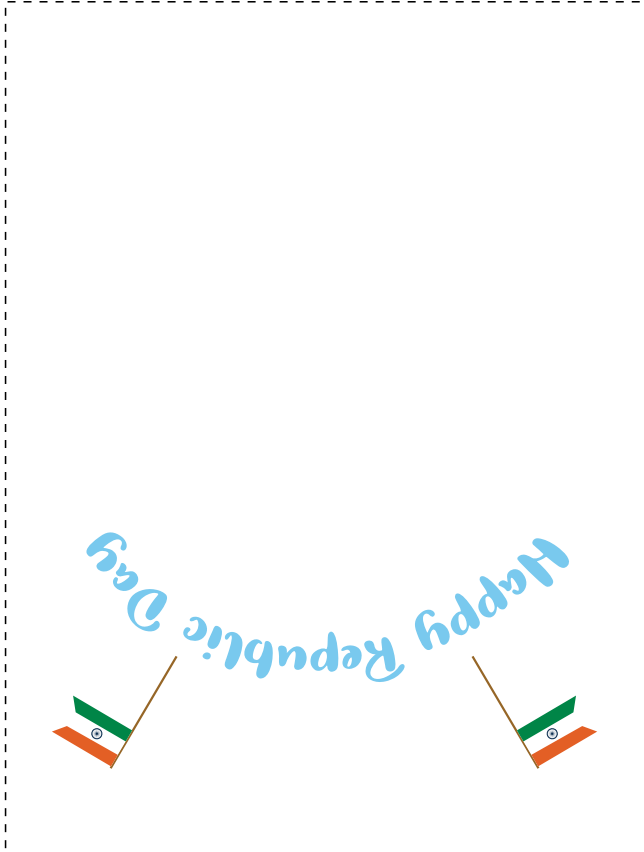
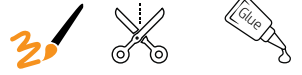

## Instructions

Step 1:  
Cut along the dotted line.

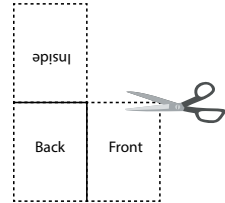

Step 2:  
Flip the card and paste  
inside flap along the centre  
line.

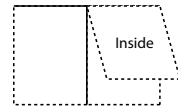

Step 3:  
Paste the inside flap to the  
back with a glue stick.

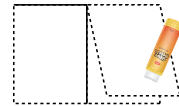

Step 4:  
Write your message.

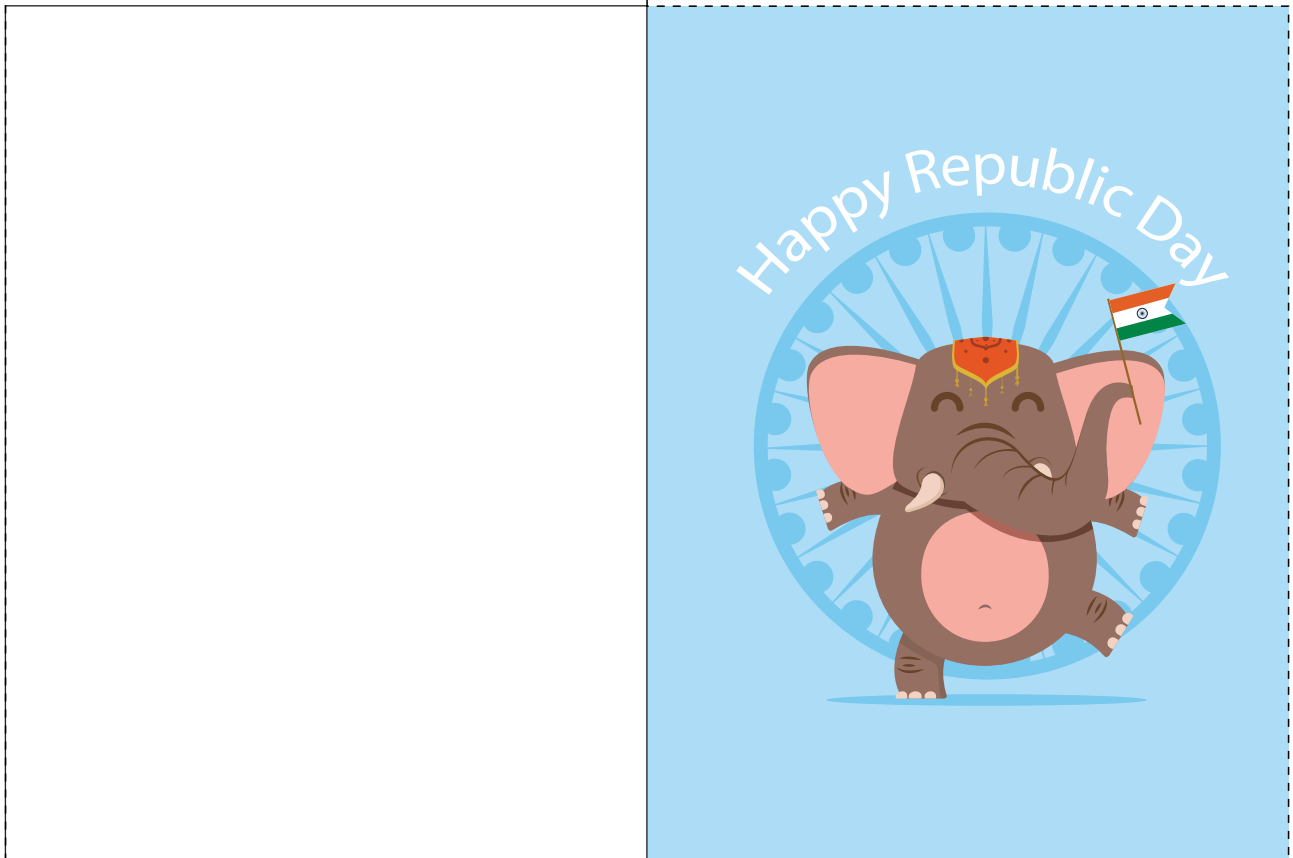
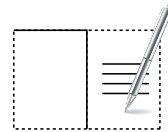

# COLOUR THE PICTURE IN SAFFRON, BLUE, AND GREEN

LEVEL: MEDIUM

ESTIMATED TIME: 20 MINUTES

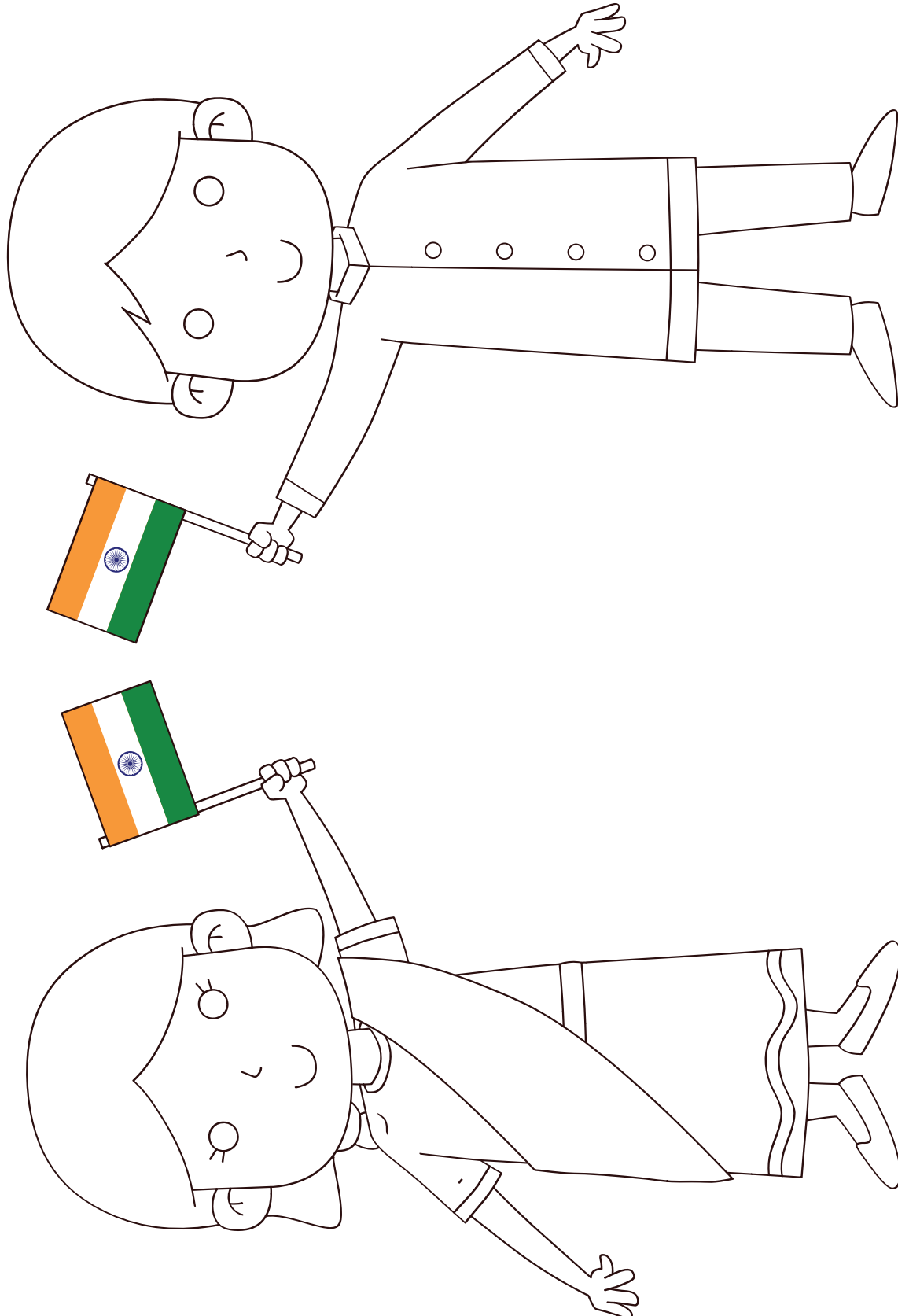

# CUT, PASTE, & BRING GANDHI JI'S CHARKHA TO LIFE

LEVEL: HIGH

ESTIMATED TIME: 30 MINUTES

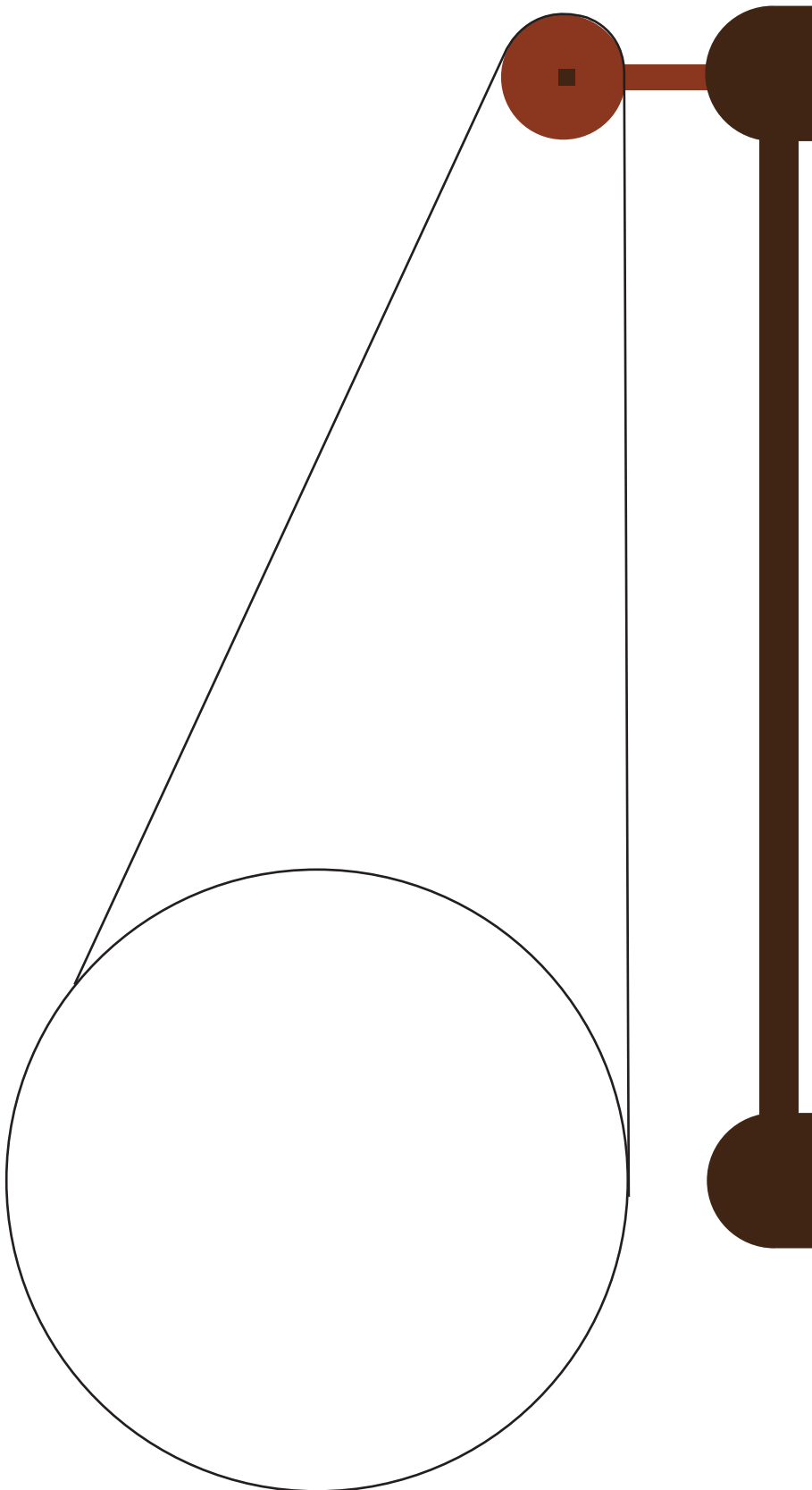

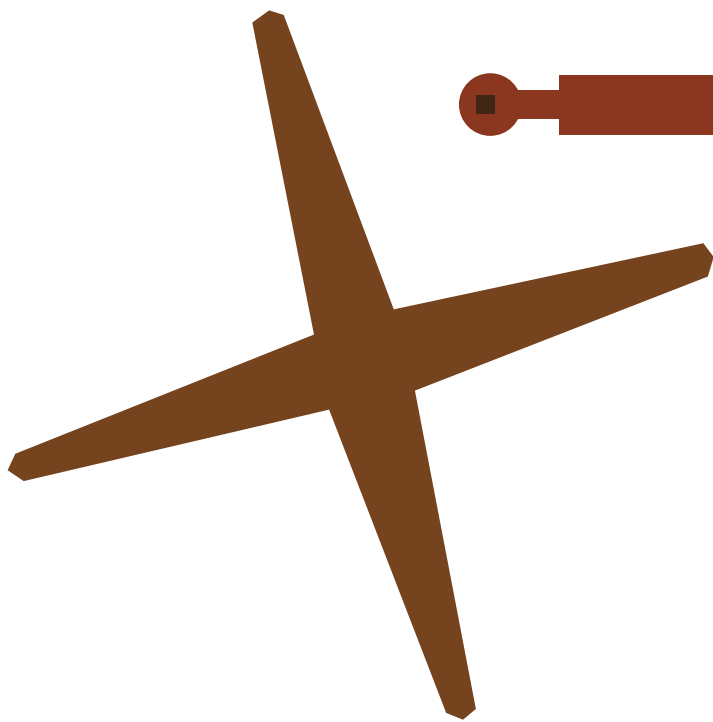
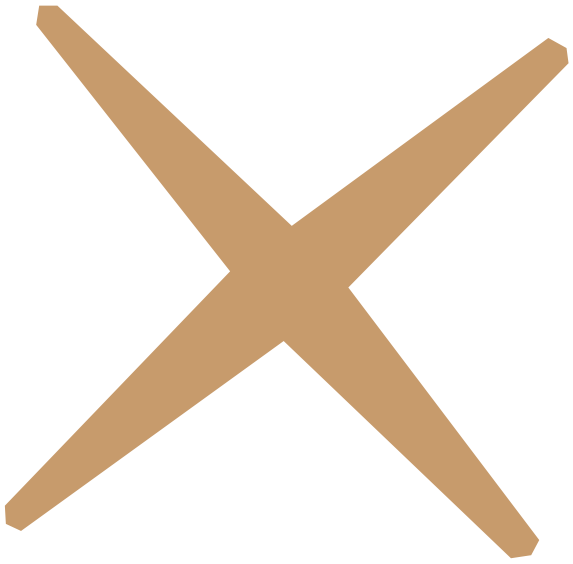

## Instructions

Step 1:  
Cut out all the visuals.

Step 2:  
Assemble and paste all the spokes and axle on the wheel, as shown in the reference image.

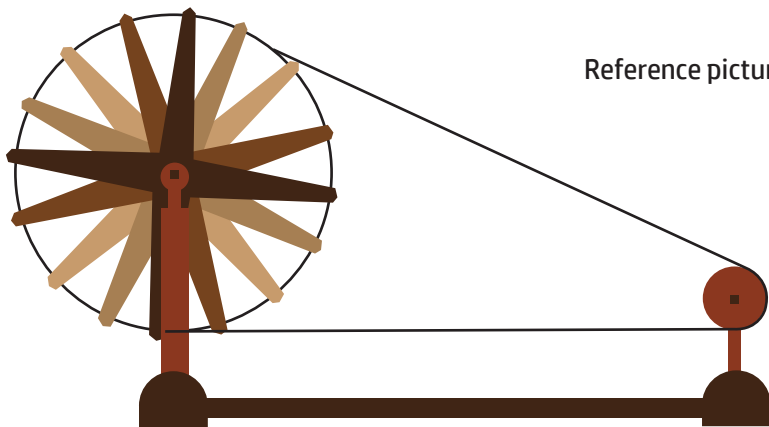

Reference picture

# DIY REPUBLIC DAY CARD

LEVEL: MEDIUM

ESTIMATED TIME: 20 MINUTES

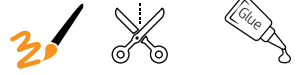

## Instructions

Step 1:  
Cut along the dotted line.

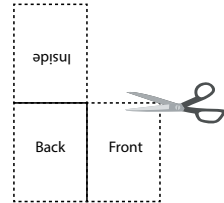

Step 2:  
Flip the card and paste  
inside flap along the centre  
line.

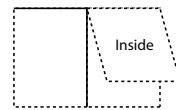

Step 3:  
Paste the inside flap to the  
back with a glue stick.

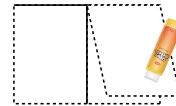

Step 4:  
Write your message.

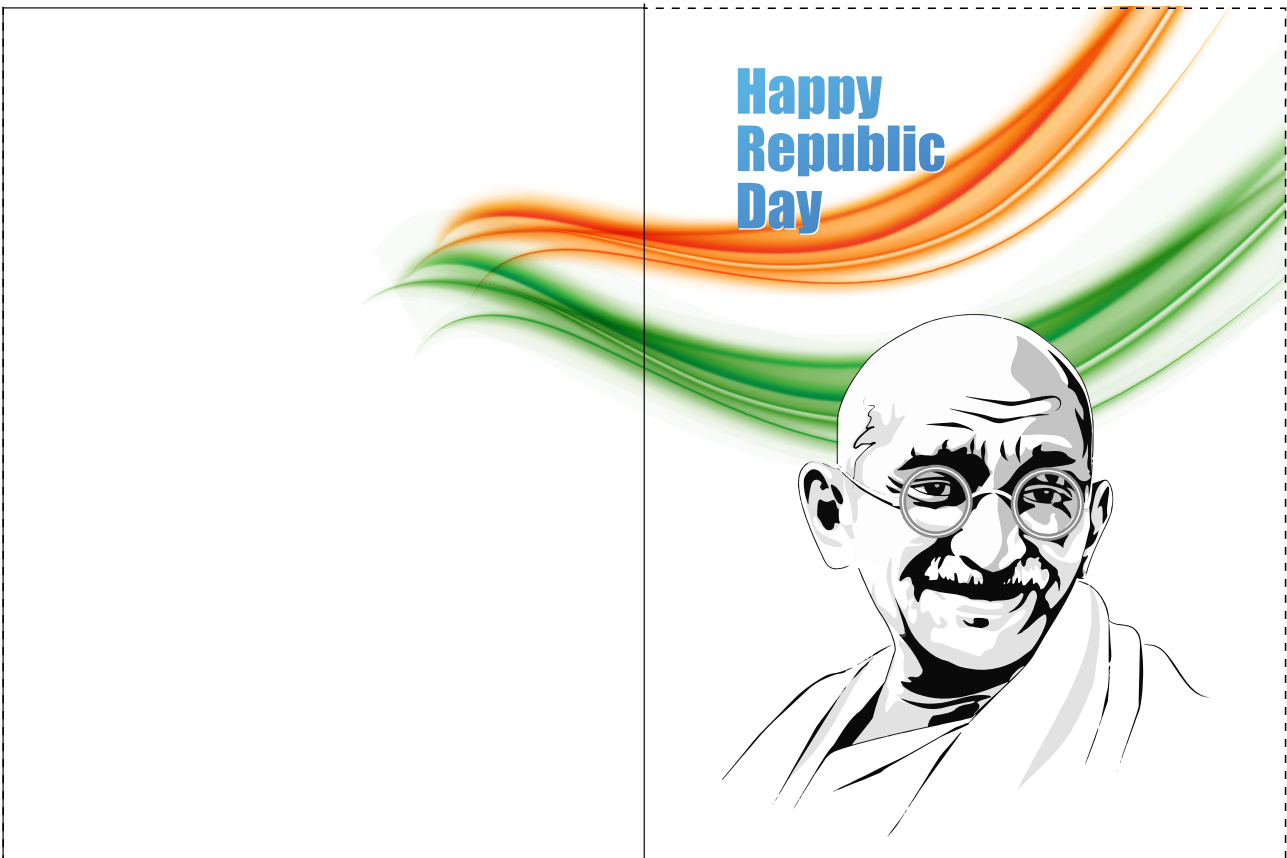
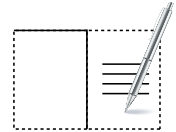

Happy  
Republic  
Day

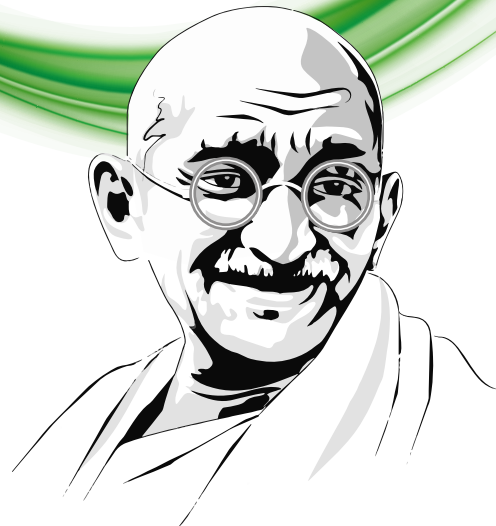

# CUT & FOLD CARD

LEVEL: MEDIUM

ESTIMATED TIME: 20 MINUTES

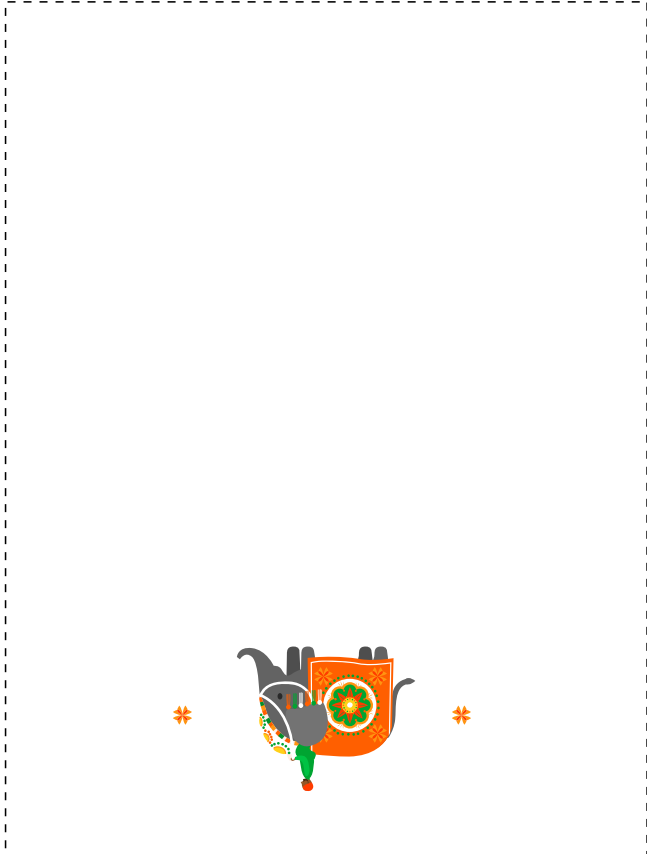
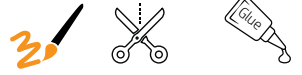

## Instructions

Step 1:  
Cut along the dotted line.

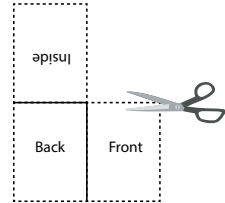

Step 2:  
Flip the card and paste  
inside flap along the centre  
line.

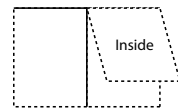

Step 3:  
Paste the inside flap to the  
back with a glue stick.

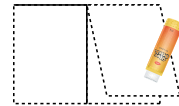

Step 4:  
Write your message.

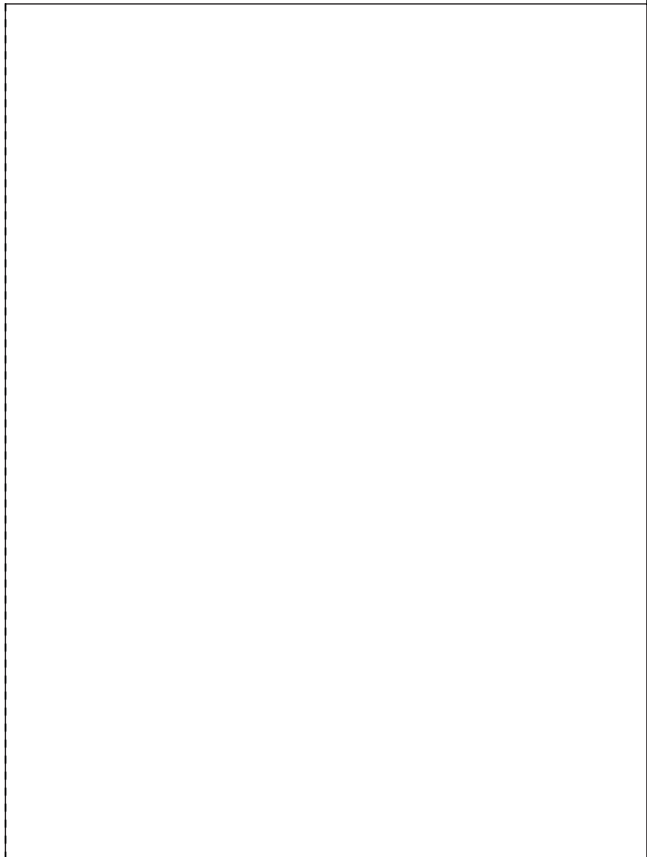
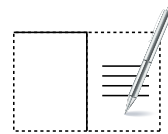

# COLOUR THE NATIONAL ANIMAL OF INDIA

LEVEL: MEDIUM

ESTIMATED TIME: 20 MINUTES

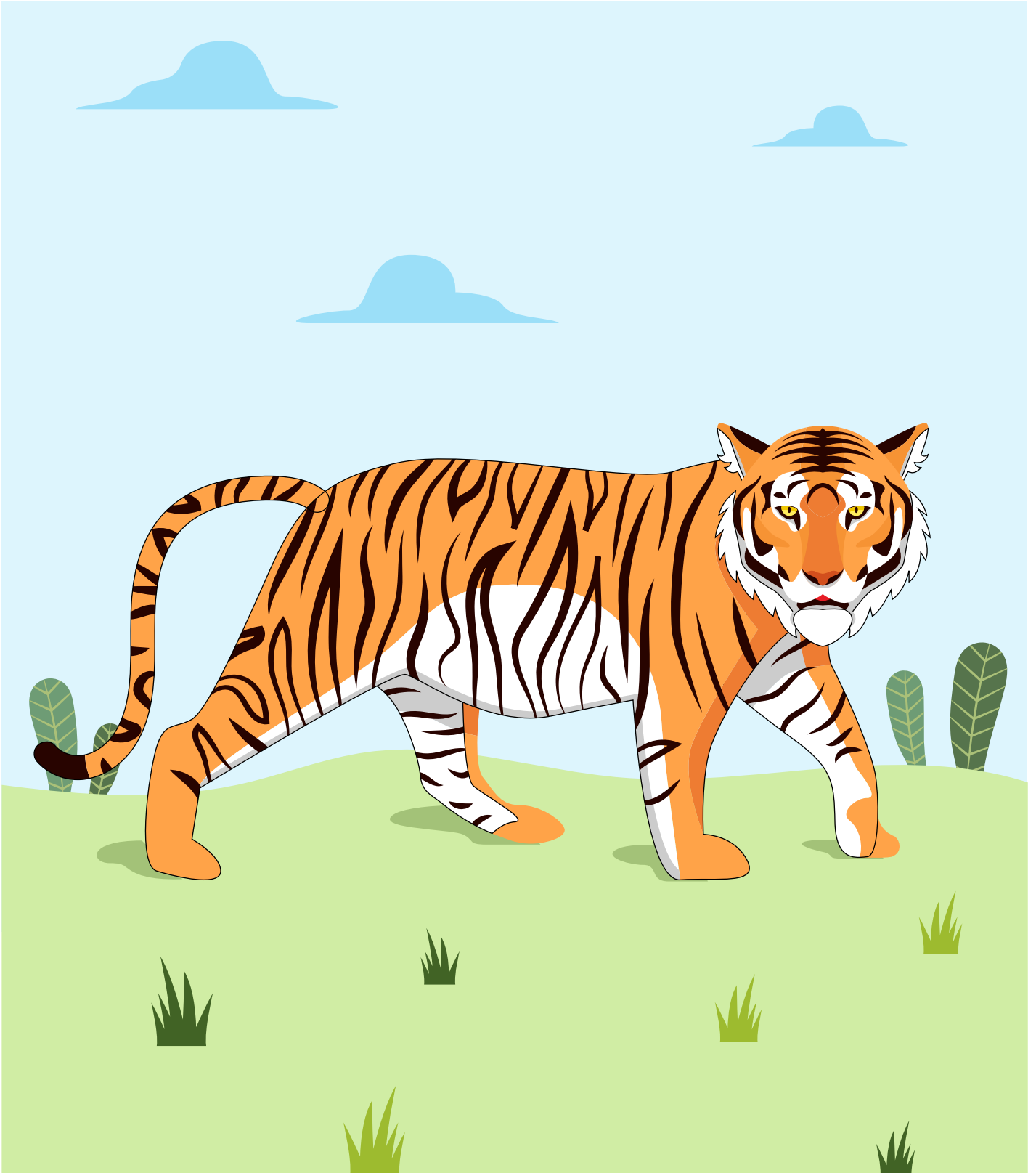

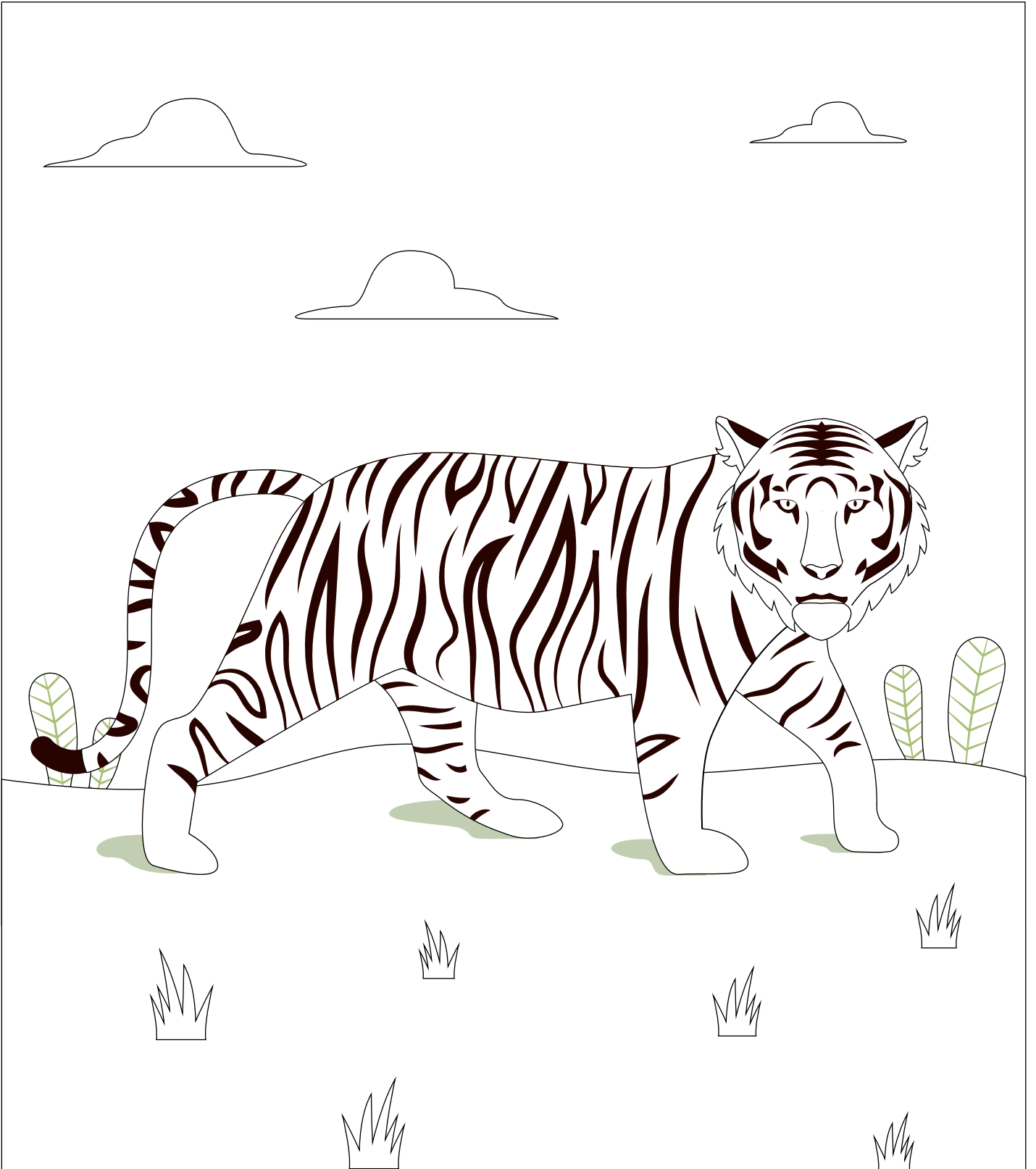

# CUT & COLOR YOUR CARD

LEVEL: MEDIUM

ESTIMATED TIME: 30 MINUTES

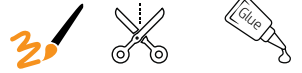

## Instructions

Step 1:  
Cut along the dotted line  
and colour on front.

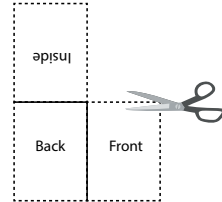

Step 2:  
Flip the card and paste  
inside flap along the centre  
line.

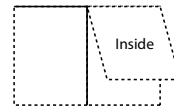

Step 3:  
Paste the inside flap to the  
back with a glue stick.

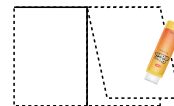

Step 4:  
Write your message.

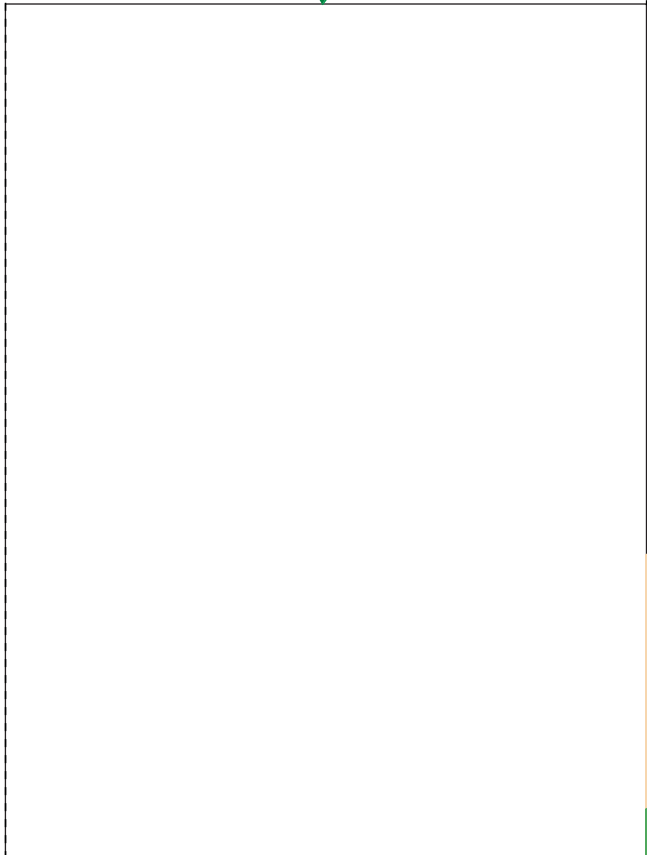
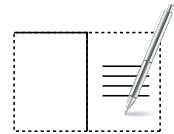

*Happy Republic Day*



# CREATE YOUR REPUBLIC DAY CARD

LEVEL: MEDIUM

ESTIMATED TIME: 20 MINUTES

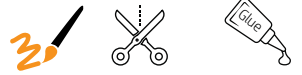

## Instructions

Step 1:  
Cut along the dotted line.

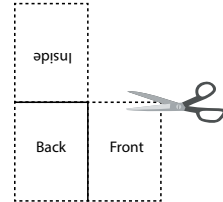

Step 2:  
Flip the card and paste  
inside flap along the centre  
line.

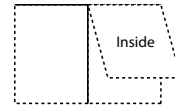

Step 3:  
Paste the inside flap to the  
back with a glue stick.

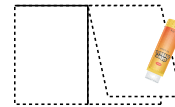

Step 4:  
Write your message.

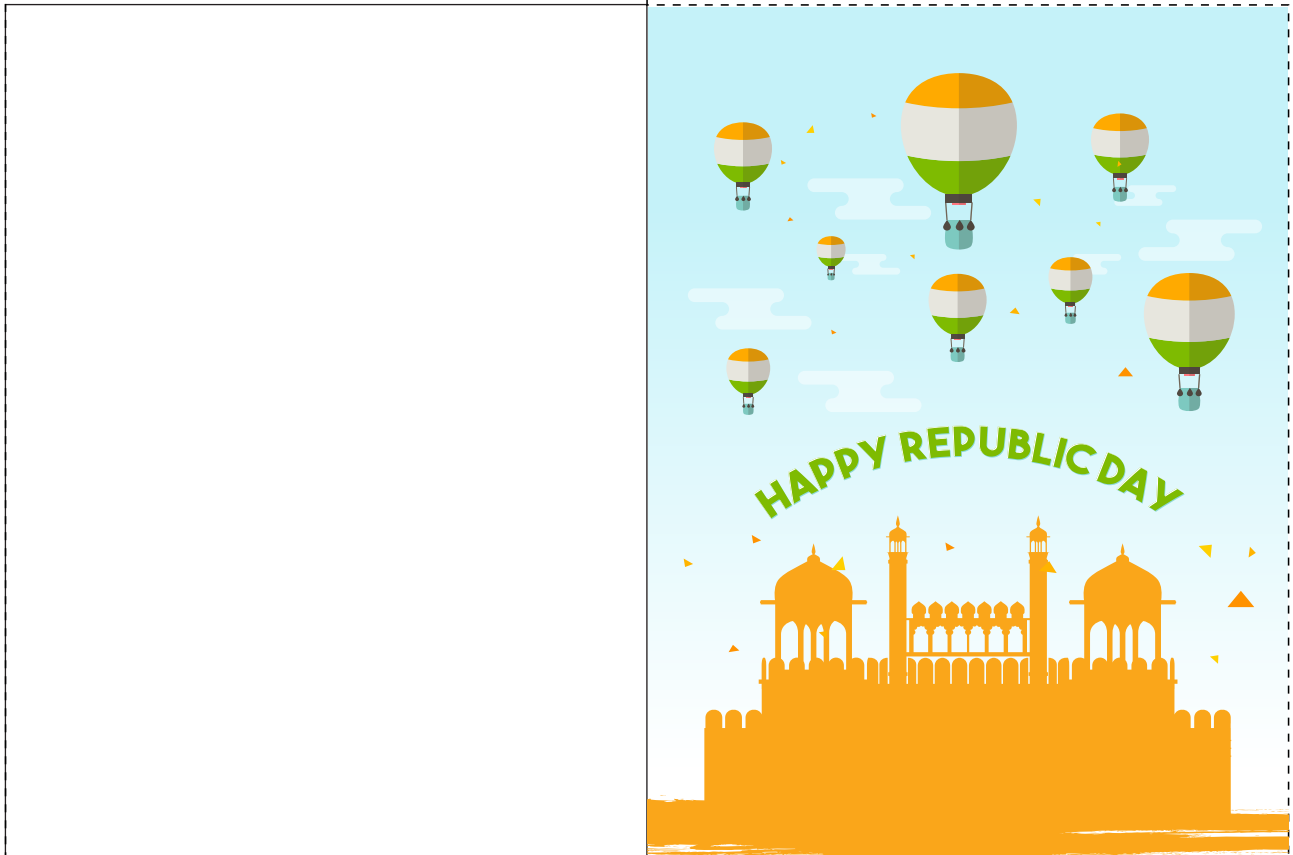
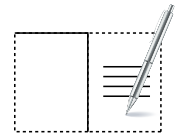

# COLOR THE NATIONAL FLOWER OF INDIA

LEVEL: HIGH

ESTIMATED TIME: 20 MINUTES

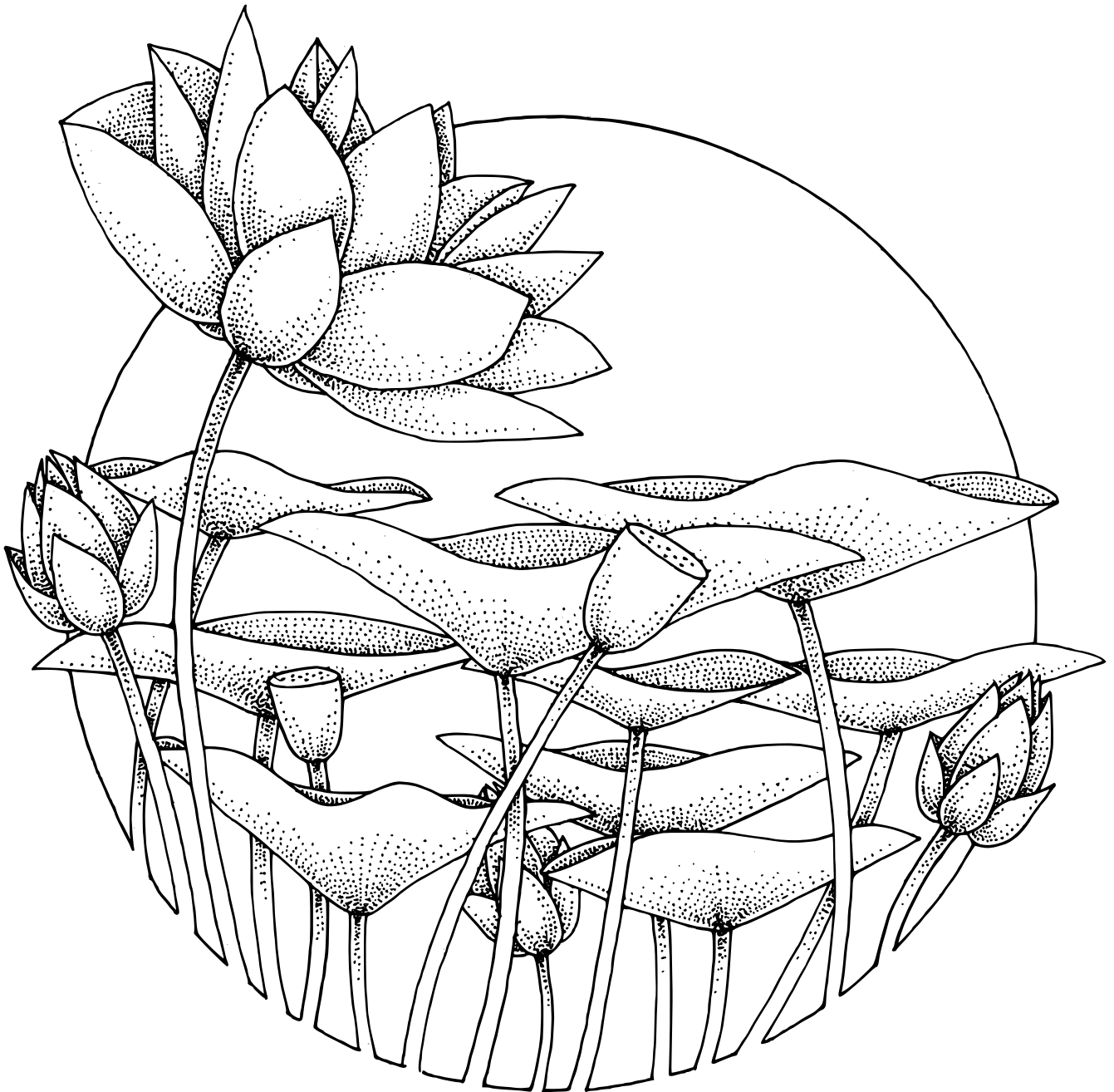

# COLOR & MAKE YOUR OWN REPUBLIC DAY CARD

LEVEL: HIGH

ESTIMATED TIME: 30 MINUTES

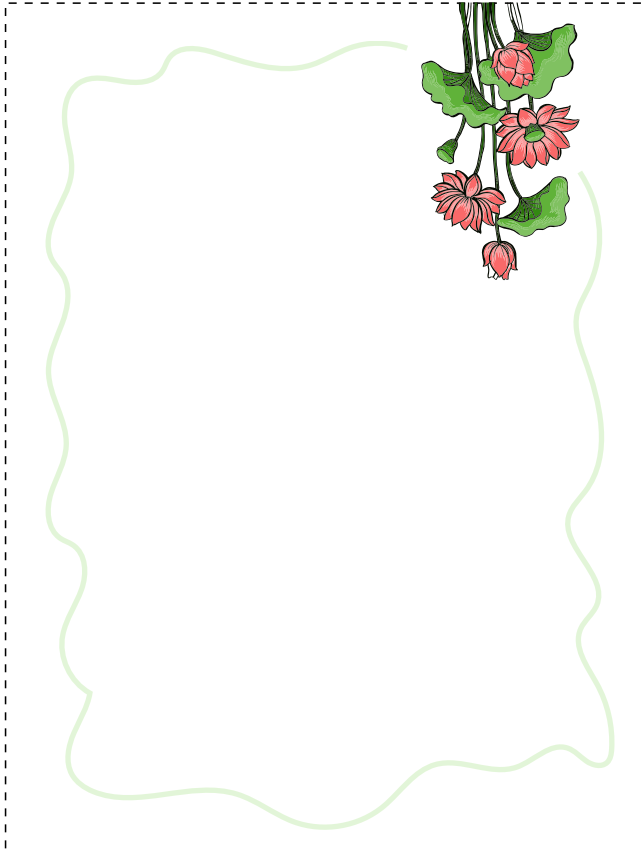

## Instructions

Step 1:  
Cut along the dotted line  
and colour on front.

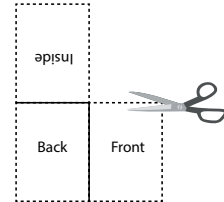

Step 2:  
Flip the card and paste  
inside flap along the centre  
line.

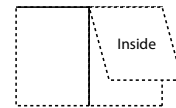

Step 3:  
Paste the inside flap to the  
back with a glue stick.

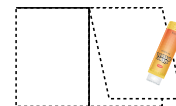

Step 4:  
Write your message.

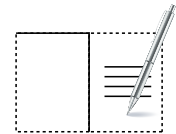

# MAKE YOUR OWN REPUBLIC DAY CARD

LEVEL: MEDIUM

ESTIMATED TIME: 20 MINUTES



## Instructions

Step 1:  
Cut along the dotted line.

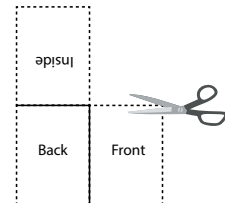

Step 2:  
Flip the card and paste  
inside flap along the centre  
line.

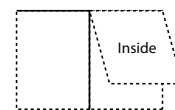

Step 3:  
Paste the inside flap to the  
back with a glue stick.

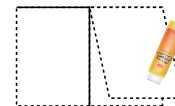

Step 4:  
Write your message.

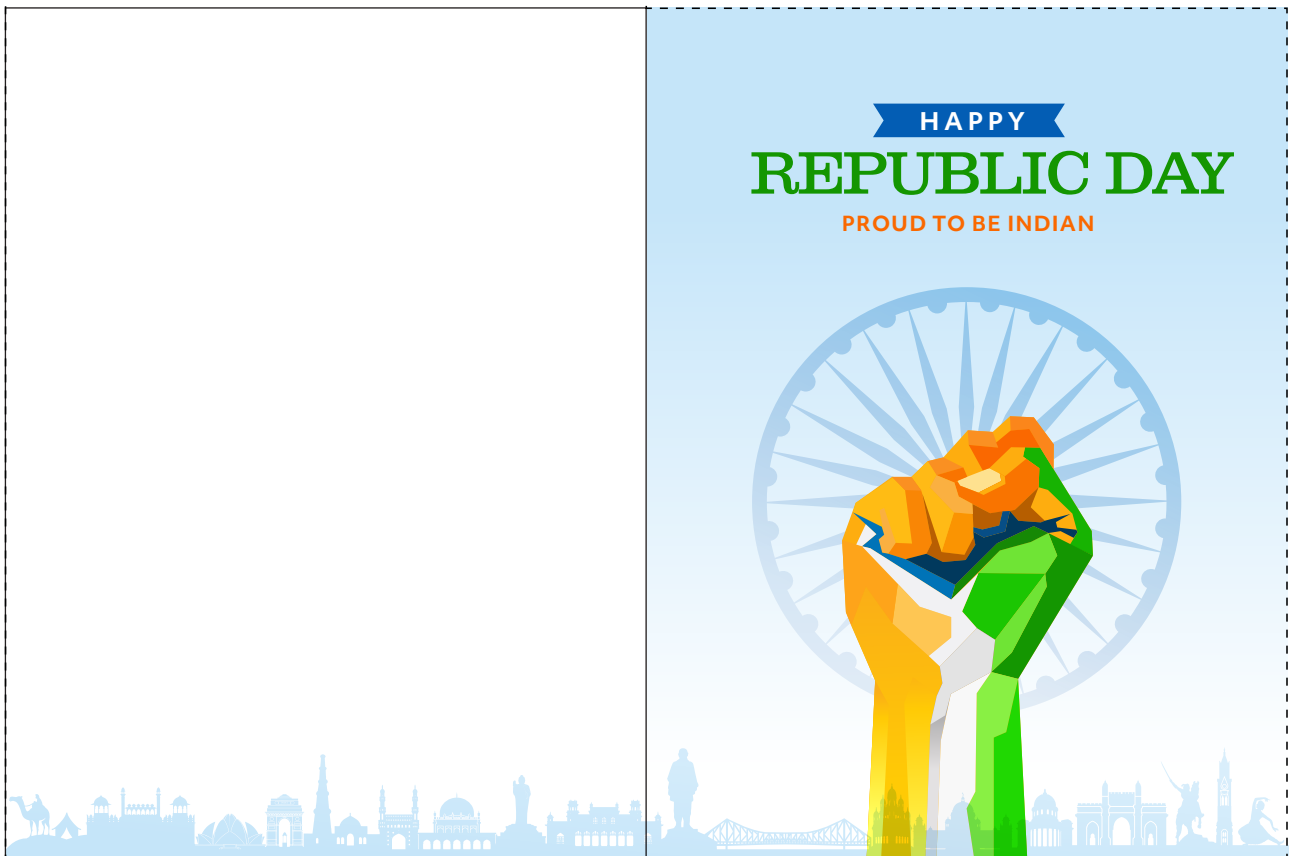
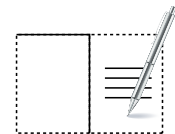

# TRACE & COLOR THE MAP OF INDIA

LEVEL: MEDIUM

ESTIMATED TIME: 20 MINUTES

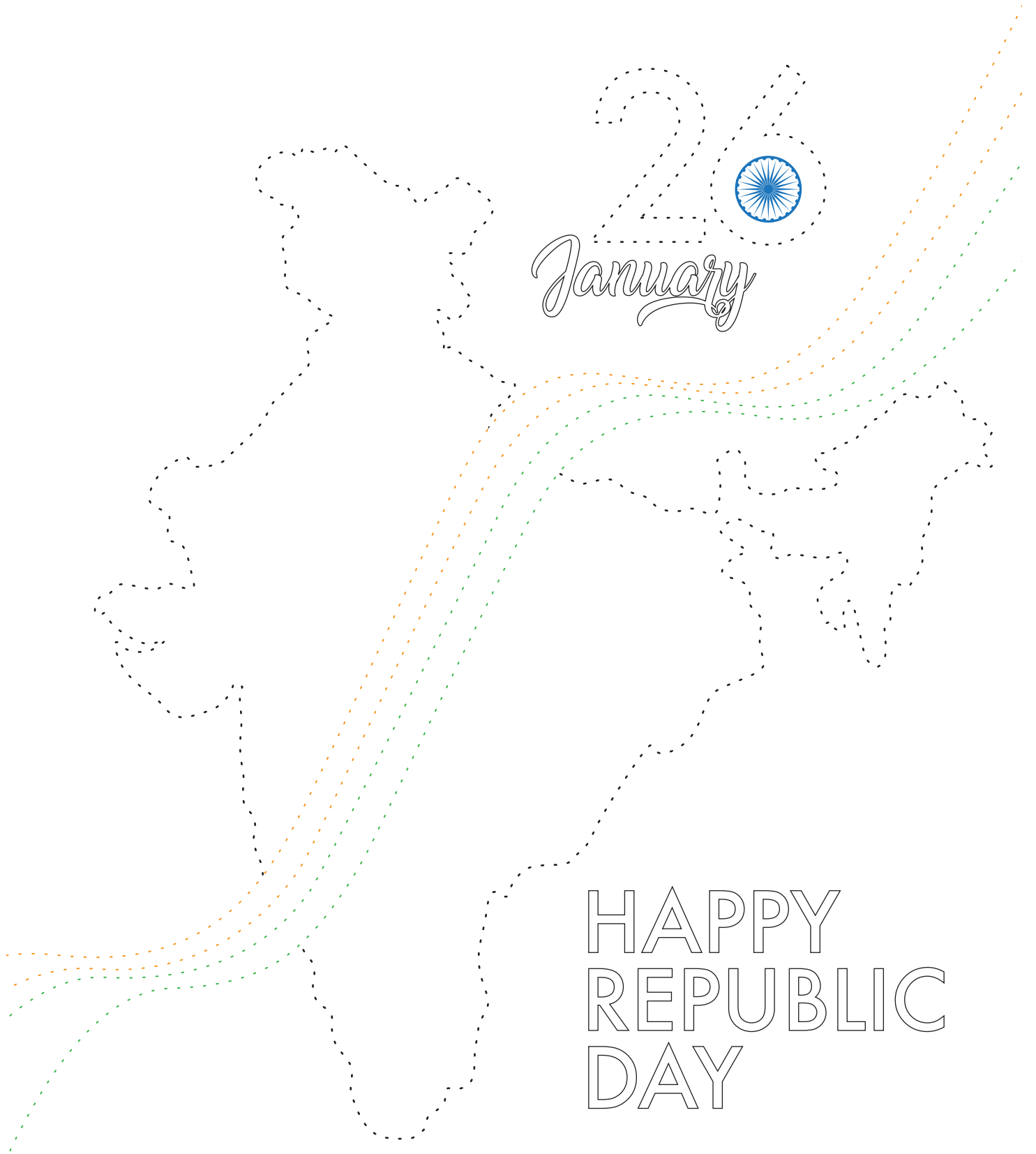

HAPPY  
REPUBLIC  
DAY

# TRACE & COLOR THE FATHER OF THE NATION

LEVEL: MEDIUM

ESTIMATED TIME: 20 MINUTES



HAPPY  
REPUBLIC  
DAY



# TRACE & COLOR THE PARADE CELEBRATION

LEVEL: MEDIUM

ESTIMATED TIME: 20 MINUTES

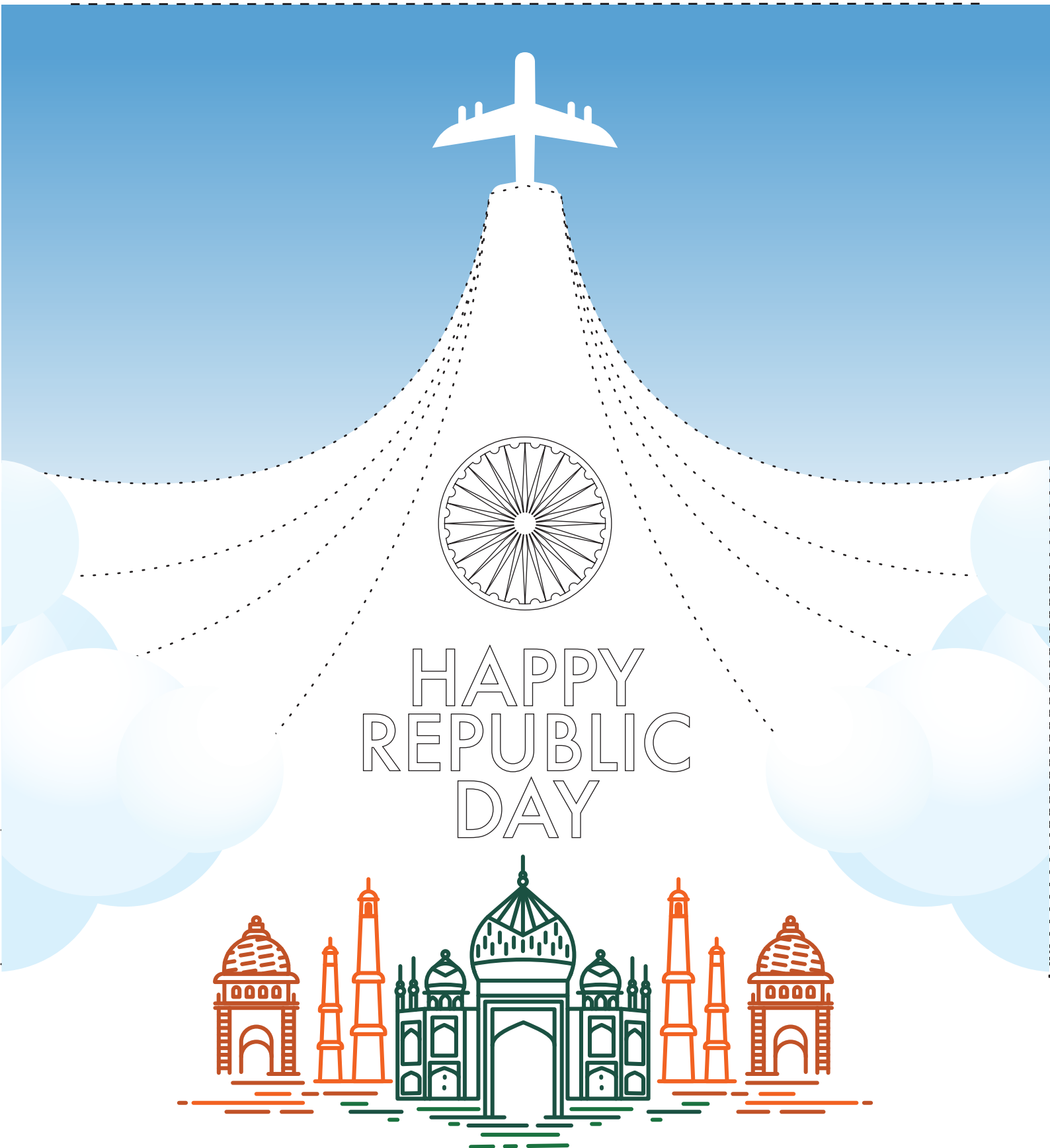

# COLOR, CUT, & MAKE YOUR PARADE JIGSAW PUZZLE

LEVEL: HIGH

ESTIMATED TIME: 30 MINUTES

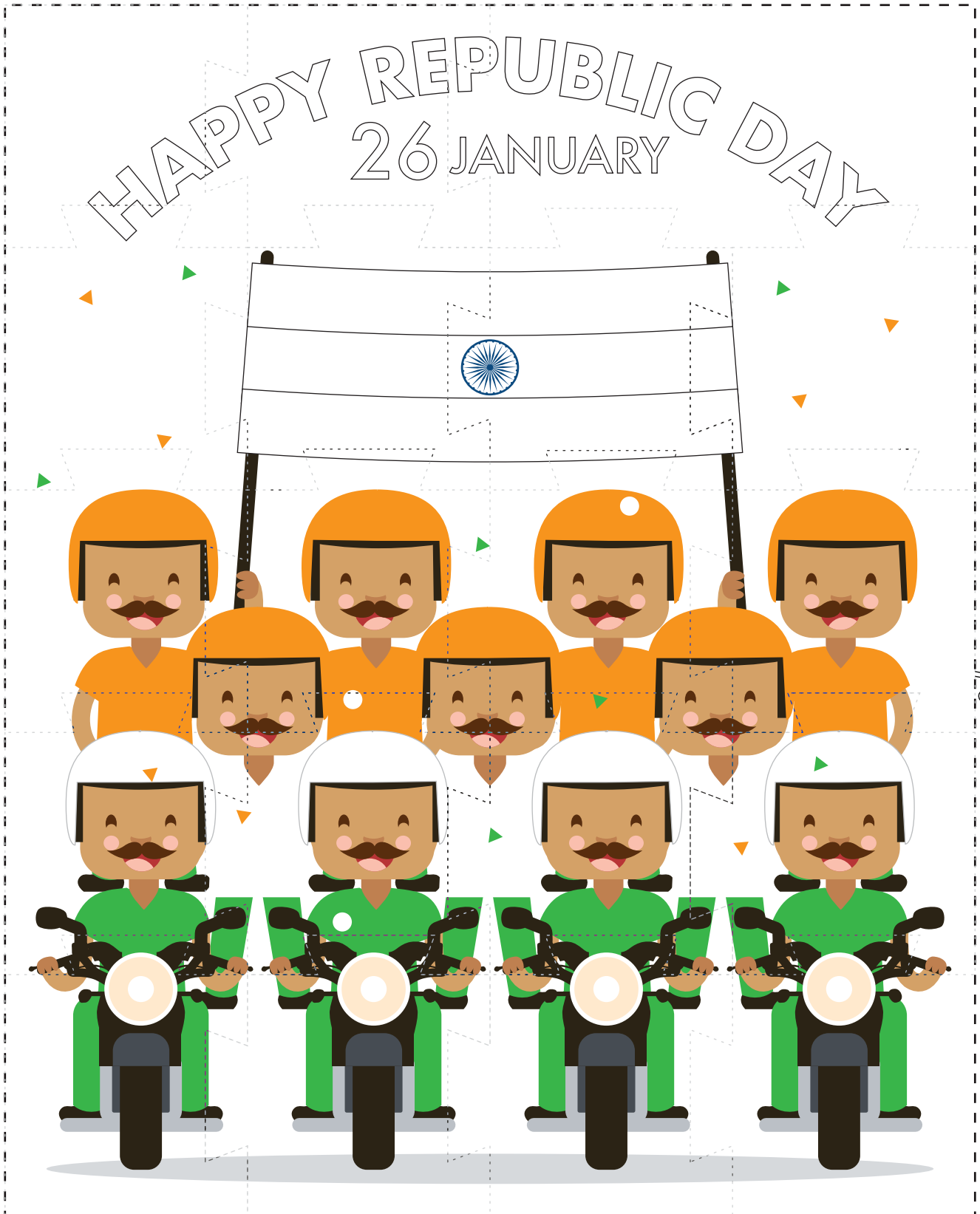

Cut along the dotted lines

# CUT & CREATE THE NATIONAL EMBLEM, ASHOK STAMBH

LEVEL: HIGH

ESTIMATED TIME: 30 MINUTES



A



B

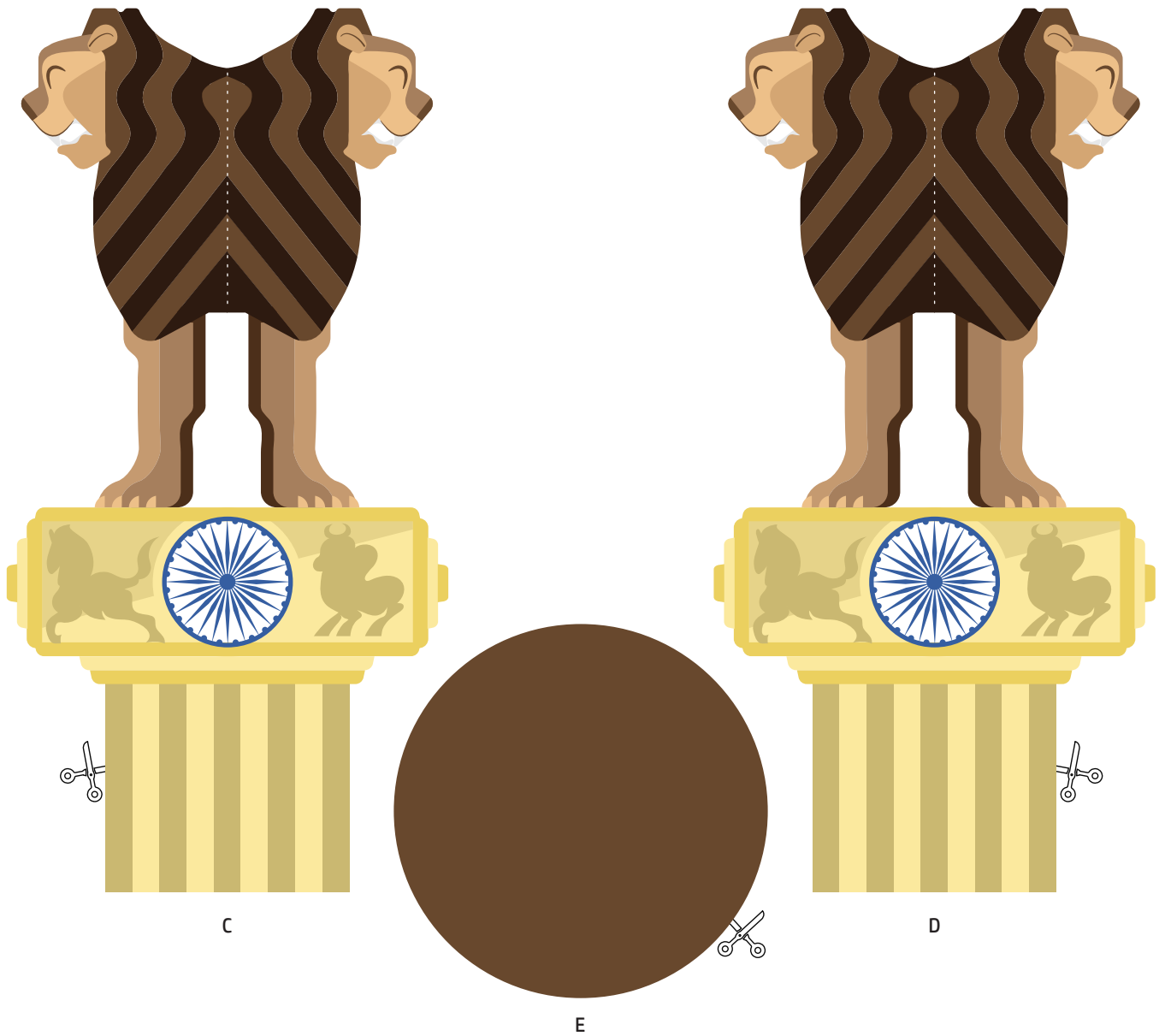

STEP 1 : Cut out A, B, C, D, and E.



STEP 2 : Paste A and B front-back and cut along the dotted line.

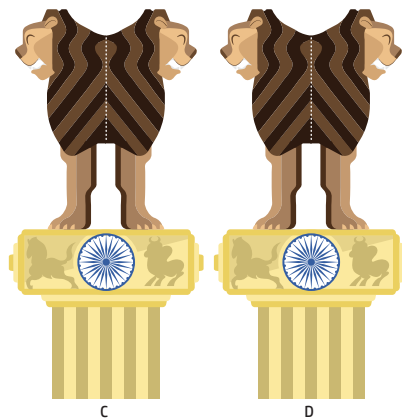

STEP 3 : Similarly, paste C and D front-back and cut along the dotted line.

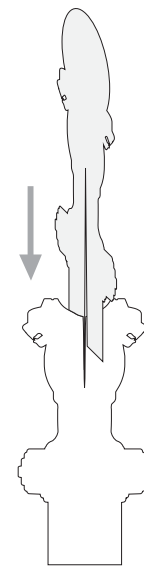

STEP 4 : Fix in the slit to make your 3D Ashok Stambh.

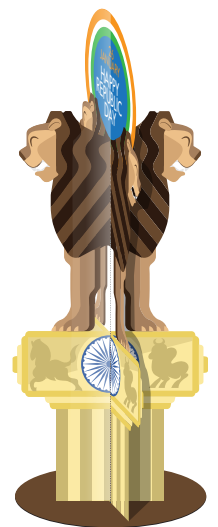

# CUT & CREATE A 3D NATIONAL FLOWER

LEVEL: MEDIUM

ESTIMATED TIME: 40 MINUTES

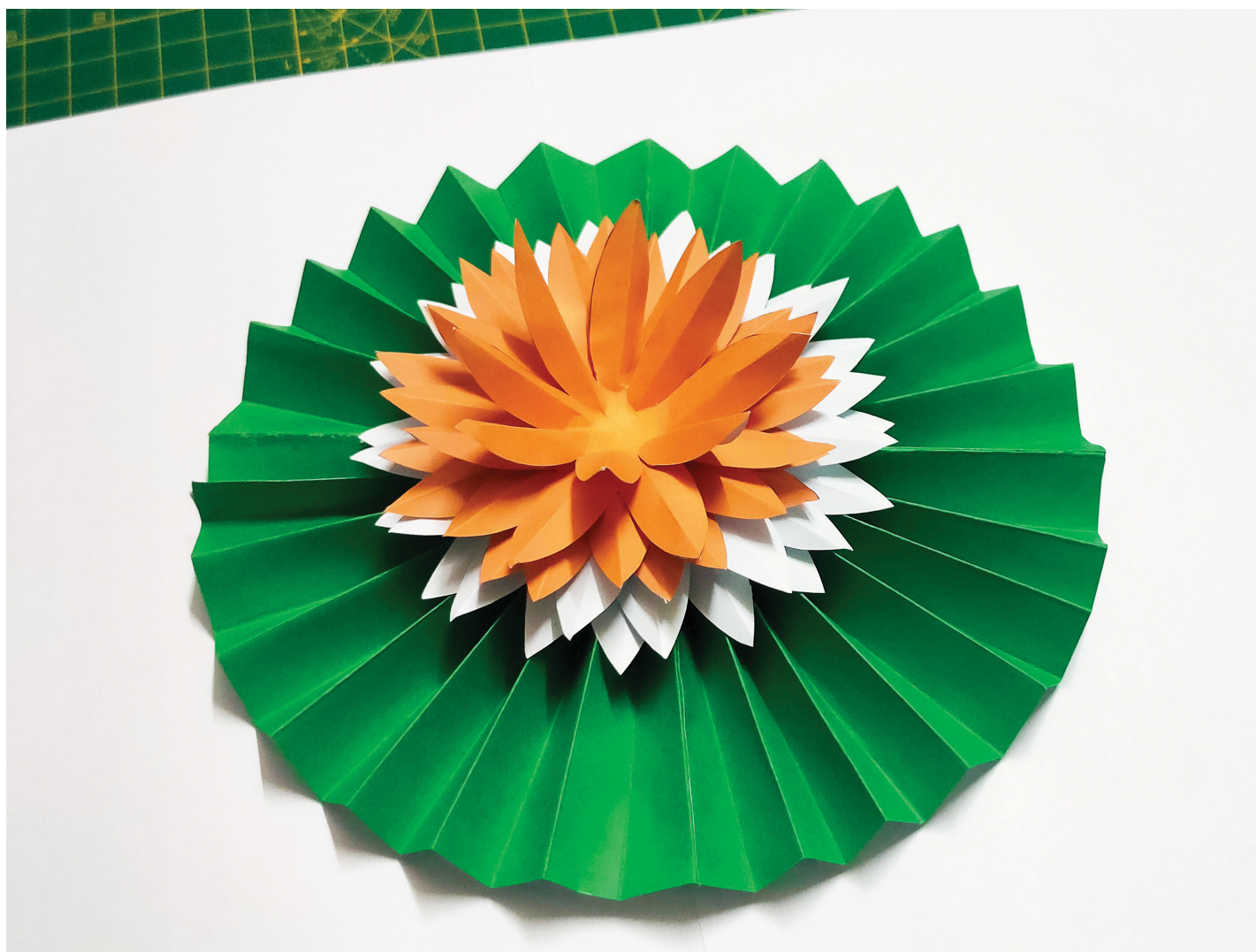
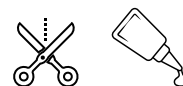

Step-1 Cut

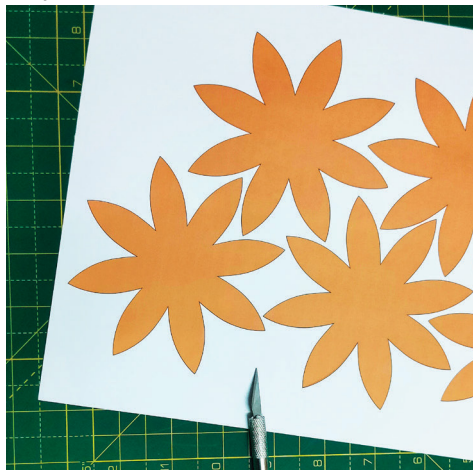

Step-2 Cut



Step-3

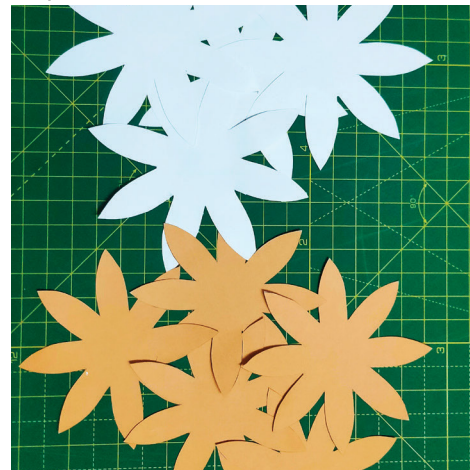

Step-4 Fold

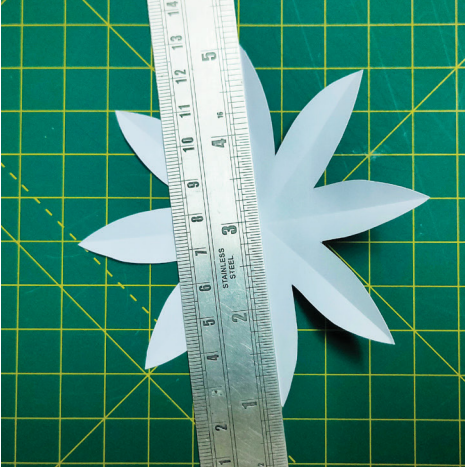

Step-5 Fold



Step-6



Step-7 Paste

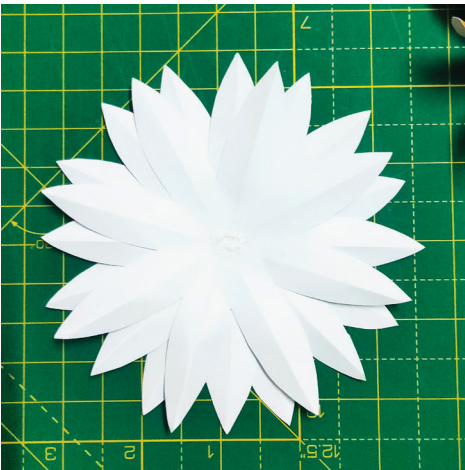

Step-8 Paste

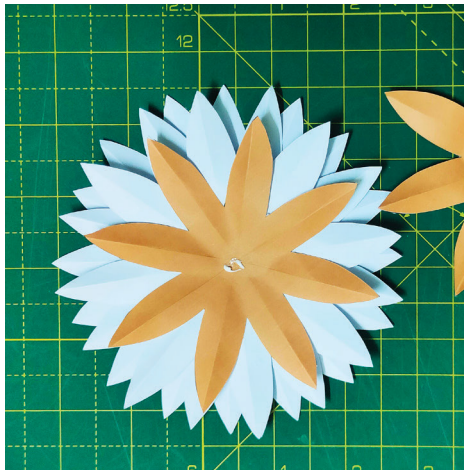

Step-9 Paste all

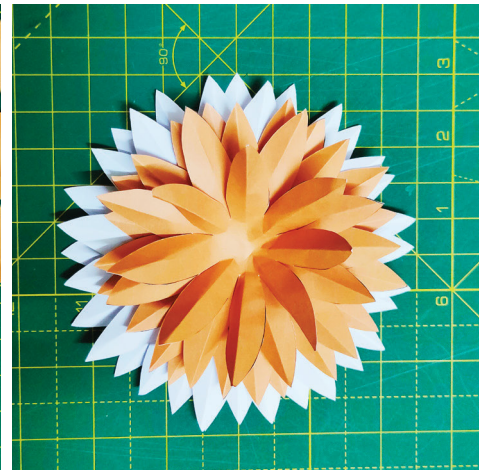

Step-10 Fold 2 sheets

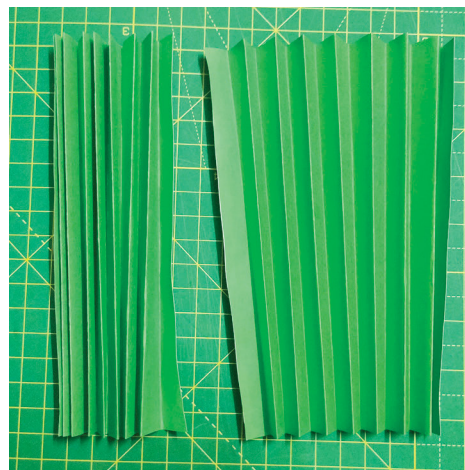

Step-11 Fold in middle and paste

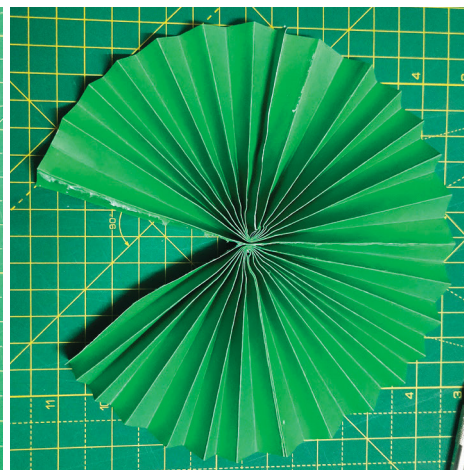

Step-12 Paste flower on top

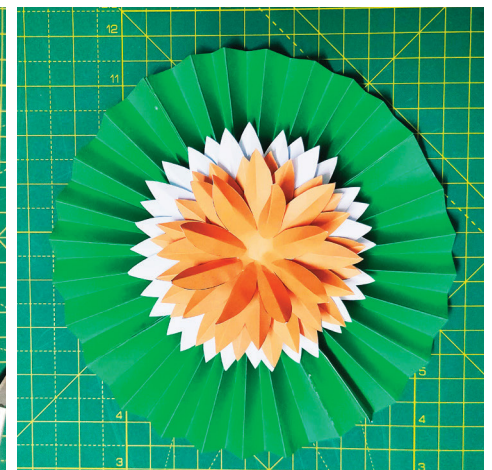

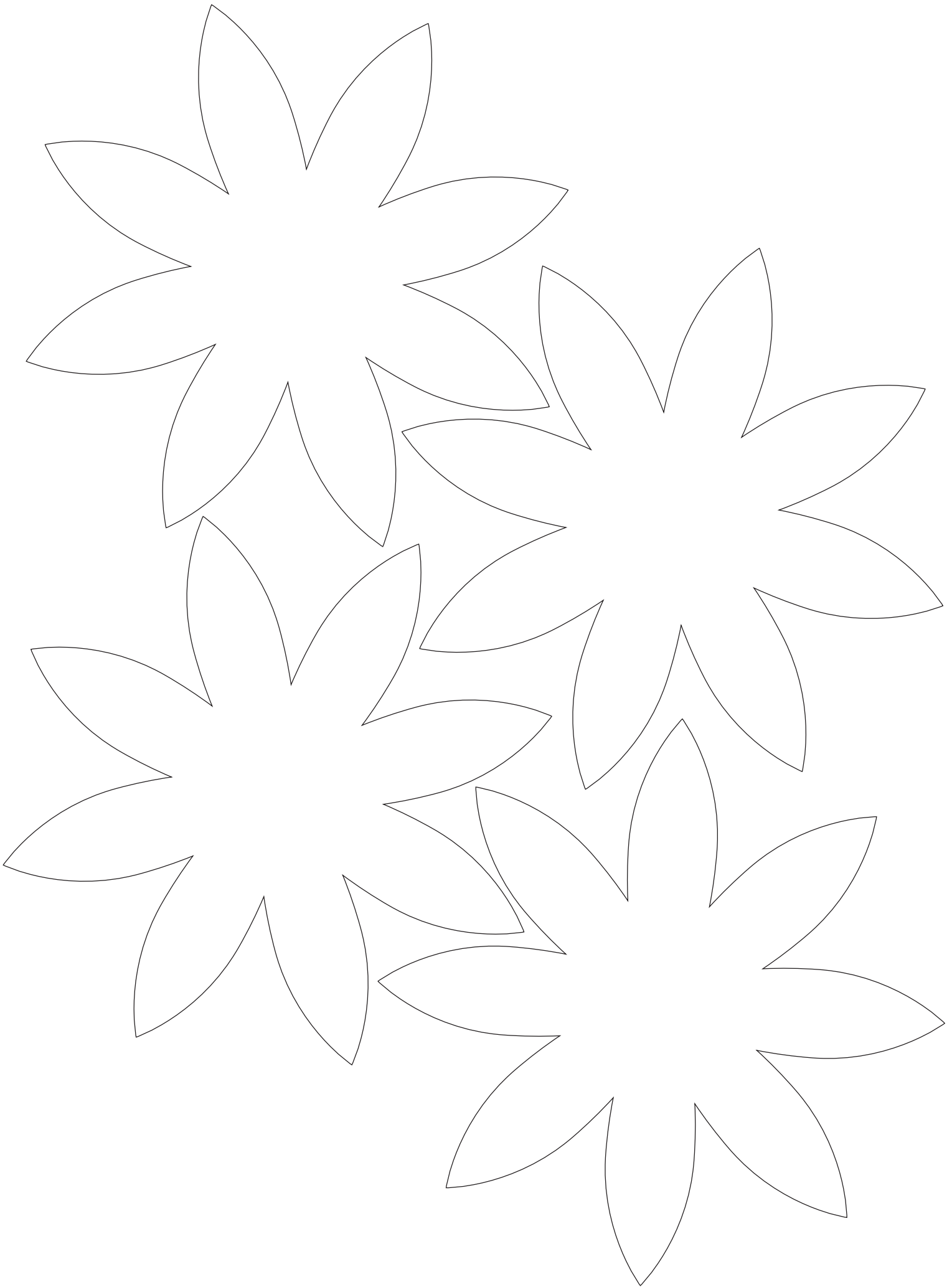





# ORIGAMI NATIONAL BIRD

LEVEL: MEDIUM

ESTIMATED TIME: 40 MINUTES

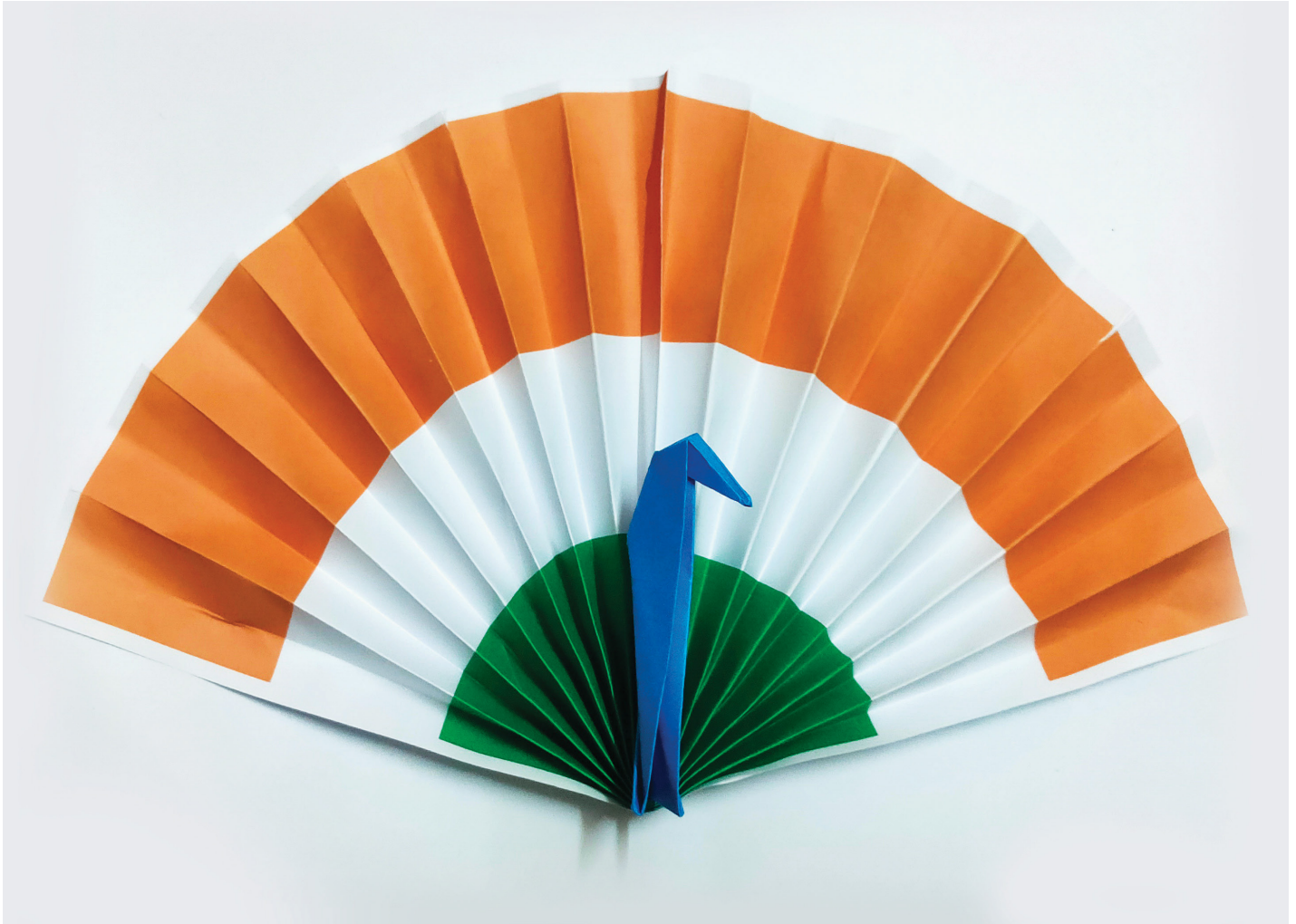
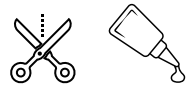

Step-1 Fold



Step-2 Fold

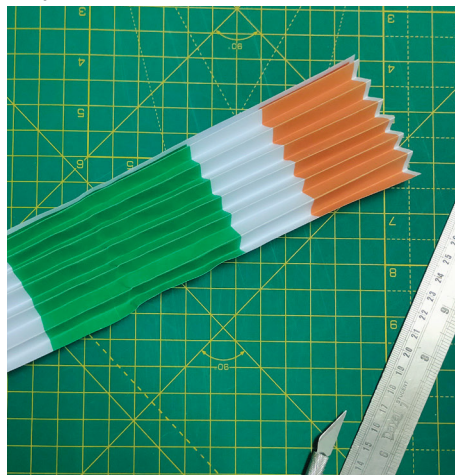

Step-3 Cut 12cmX12cm

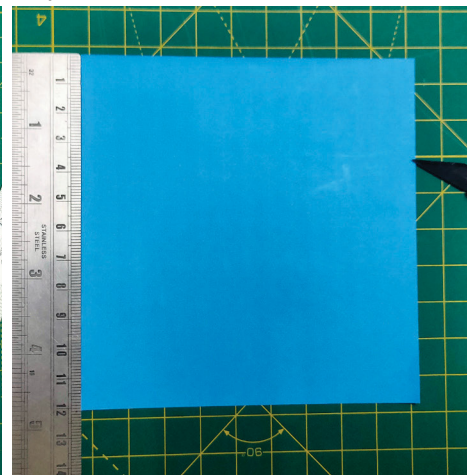

Step-4 Fold

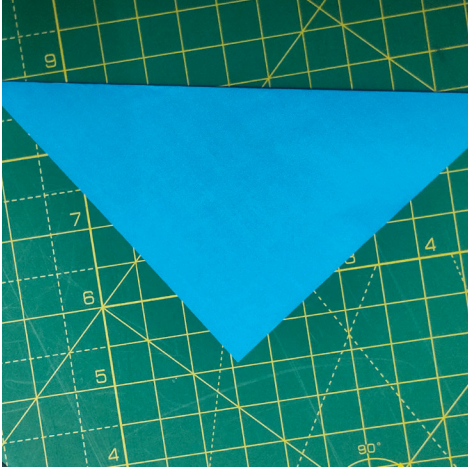

Step-5 Fold

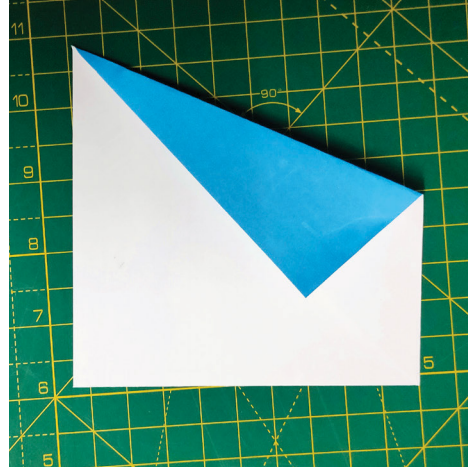

Step-6 Fold

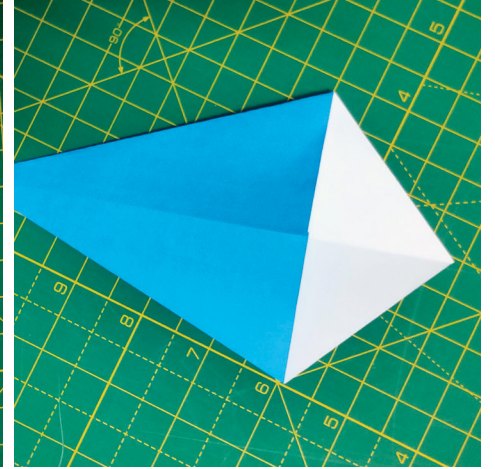

Step-7 Fold

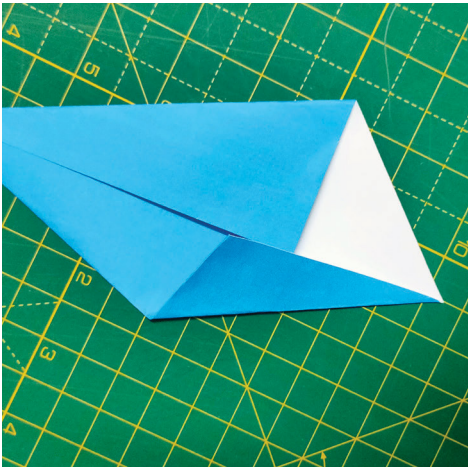

Step-8 Fold

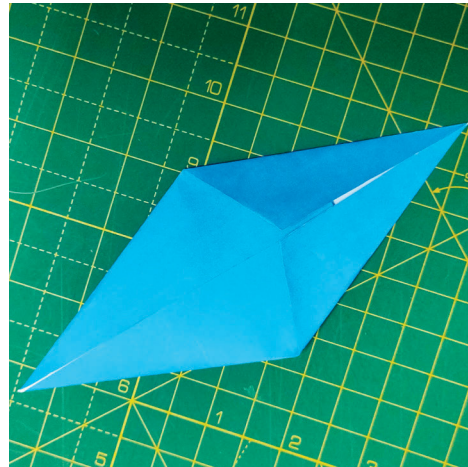

Step-9 Fold

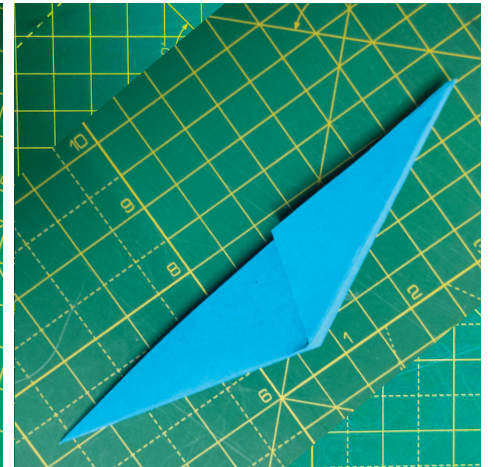

Step-1 Fold

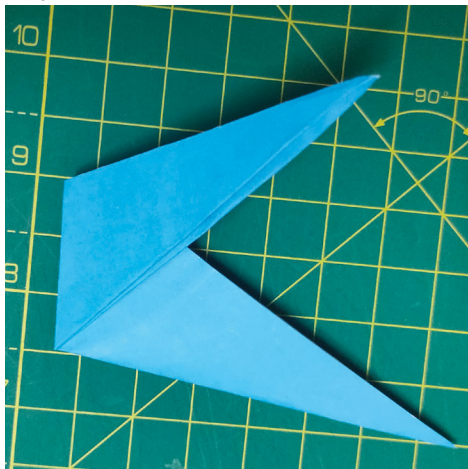

Step-2 Fold

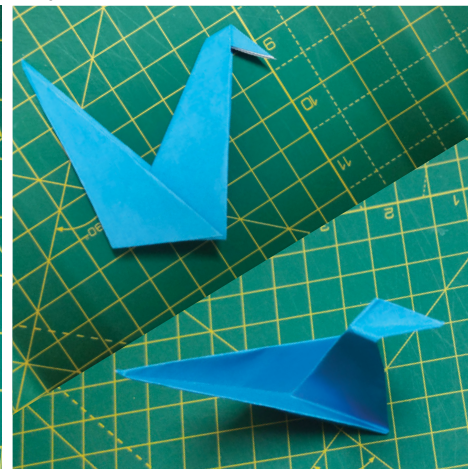

Step-Fold and Paste







# HISTORY IN A BOX

LEVEL: **HARD**

ESTIMATED TIME: **50 MINUTES**

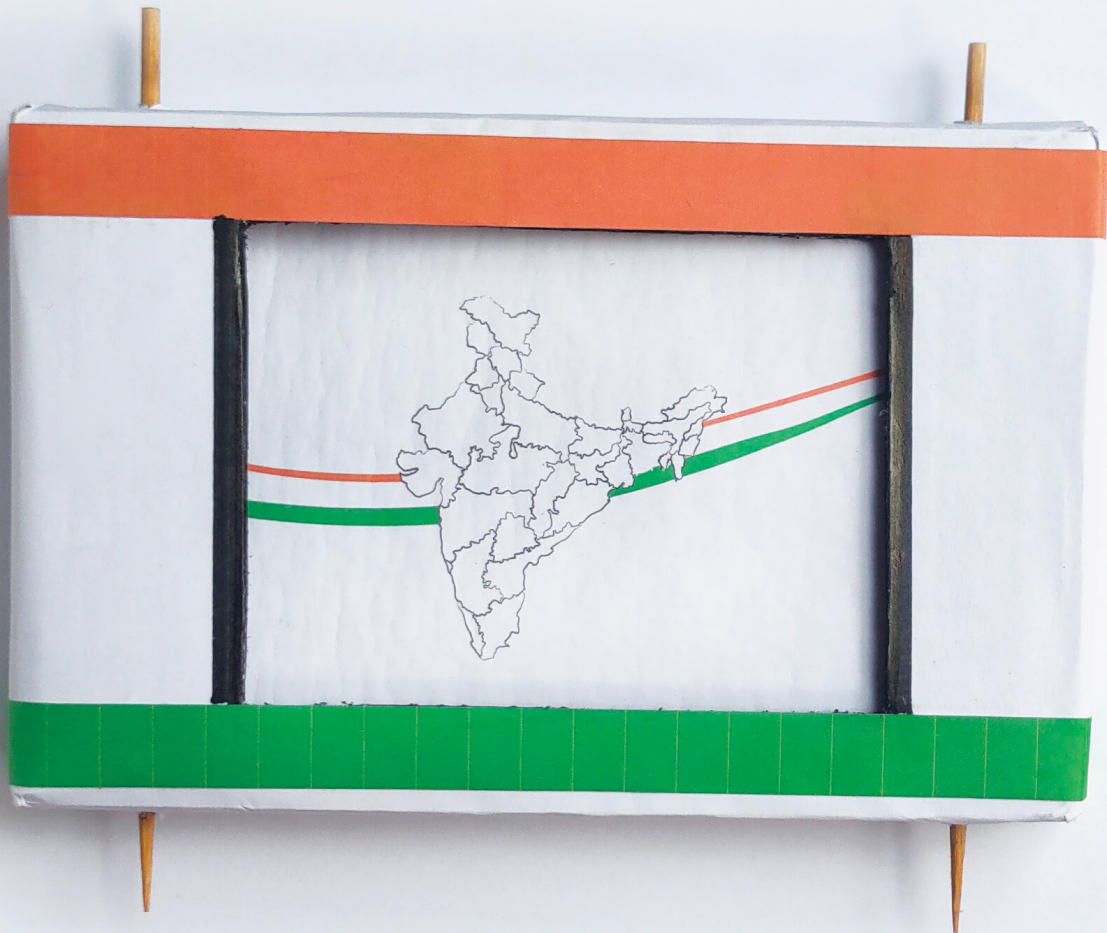

Step-1 Measure size with cardboard box

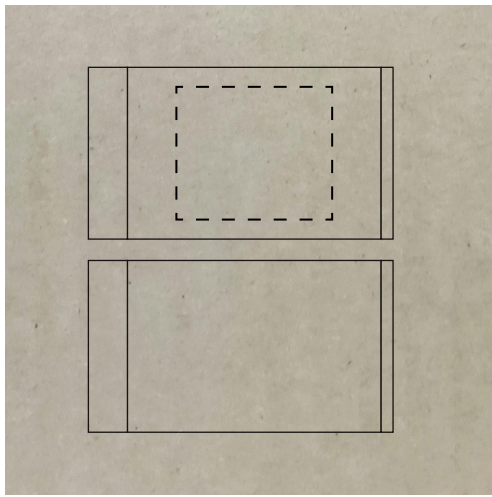

Step-2 Cut the window

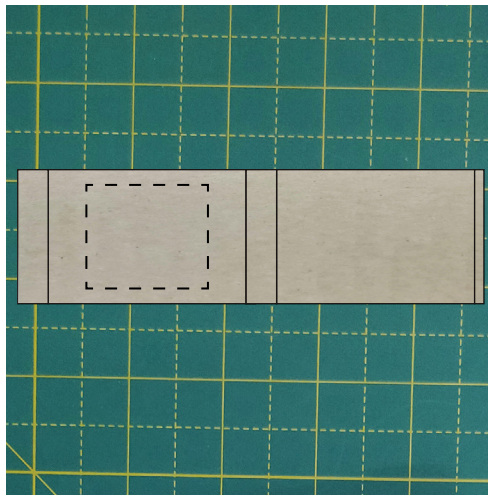

Step-3 Cut and join the edge



Step-4 Cut the top and bottom part



Step-5 Fold



Step-6 Find 2 hard sticks

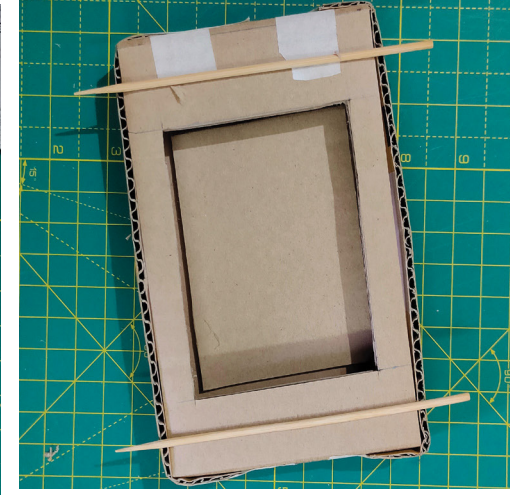

Step-7 Paste all



Step-8 Cut illustrations

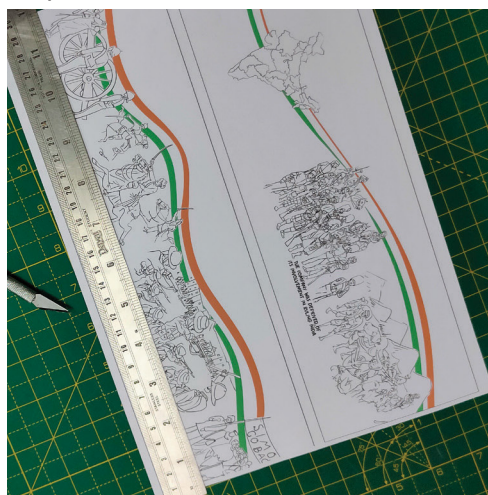

Step-9 Paste all side by side



Step-10 Stick the paper



Step-12 Roll it



Step-13 Cover with white paper and cut the window. Put colored strips on top and bottom.



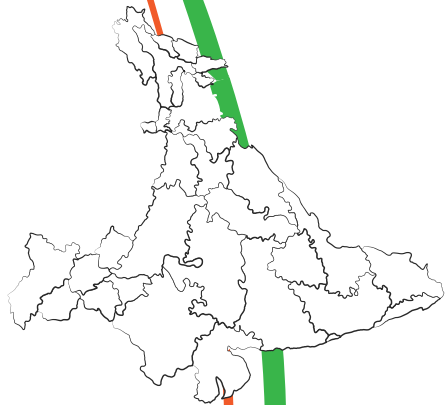

THE COMPANY WAS DEPRIVED OF ITS INVOLVEMENT IN RULING INDIA

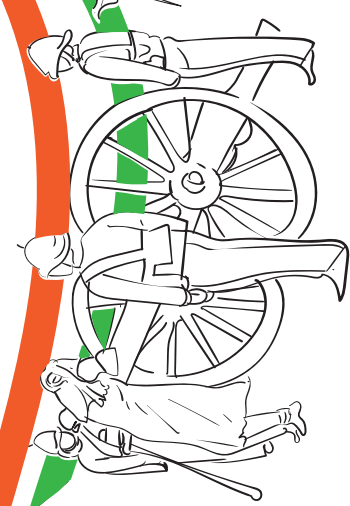

JUNE 18 1858 RANI LAKSHMI BAI OF JHANSI DIES WHILE FIGHTING THE BRITISH TROOPS NEAR GWALIOR



MASSACRE OF JALLIANWALA BAGH ON APRIL 13, 1919



SLAM ON  
GO BACK

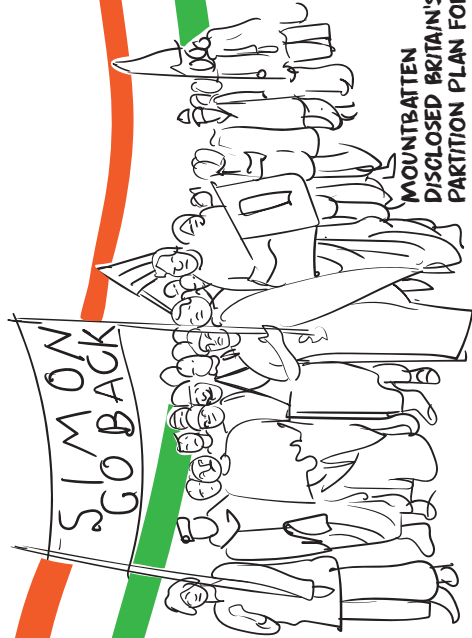

MOUNTBATTEN  
DISCLOSED BRITAIN'S  
PARTITION PLAN FOR INDIA



INDIAN NATIONAL ARMY



INDIAN NATIONAL MOVEMENT



MOVEMENT



HEROES OF INDIA



MOUNTBATTEN DISCLOSED  
BRITAIN'S PARTITION PLAN FOR INDIA

THE GOVT  
ADVISOR  
CONSTITUTION 26  
AND GOVT  
ON 26

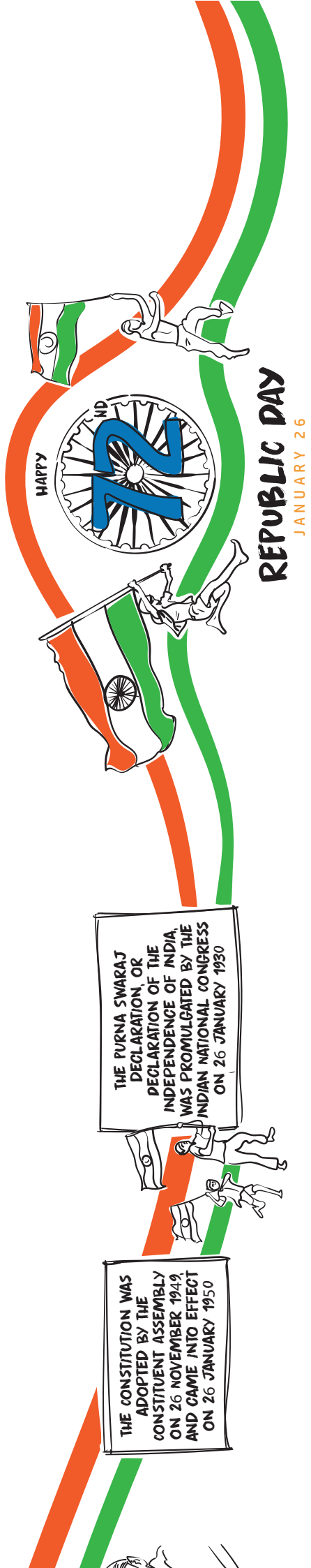

THE PURNA SWARAJ  
DECLARATION OR  
DECLARATION OF THE  
INDEPENDENCE OF INDIA  
WAS PROMULGATED BY THE  
INDIAN NATIONAL CONGRESS  
ON 26 JANUARY 1930

THE CONSTITUTION WAS  
ADOPTED BY THE  
CONSTITUENT ASSEMBLY  
ON 26 NOVEMBER 1949,  
AND CAME INTO EFFECT  
ON 26 JANUARY 1950

# REPUBLIC DAY

JANUARY 26



Use Cardboard Carton Box 6.5 inch X 4.4 inch X 1 inch

Paste the paper into cardboard Carton Box, then cut.

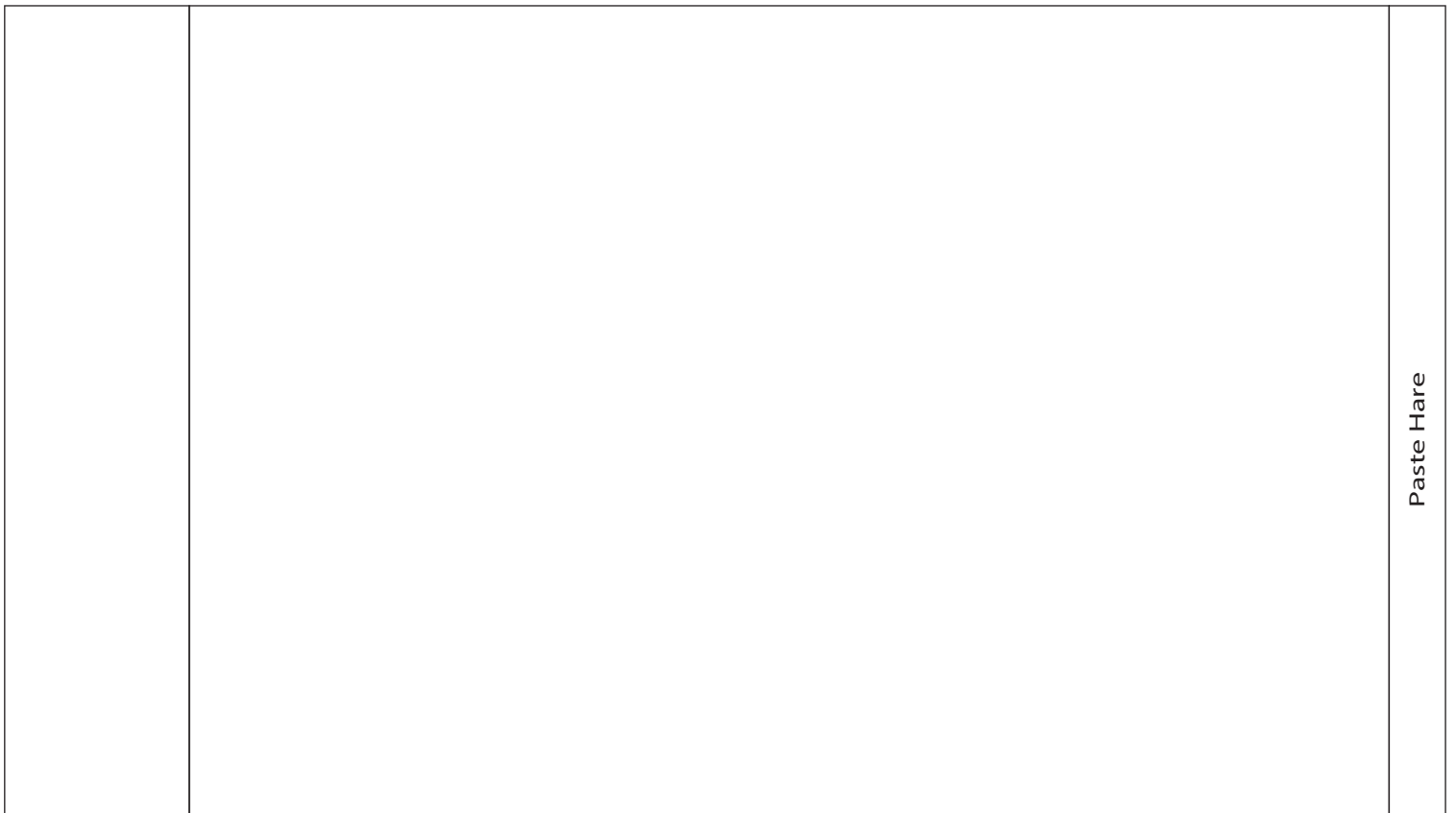
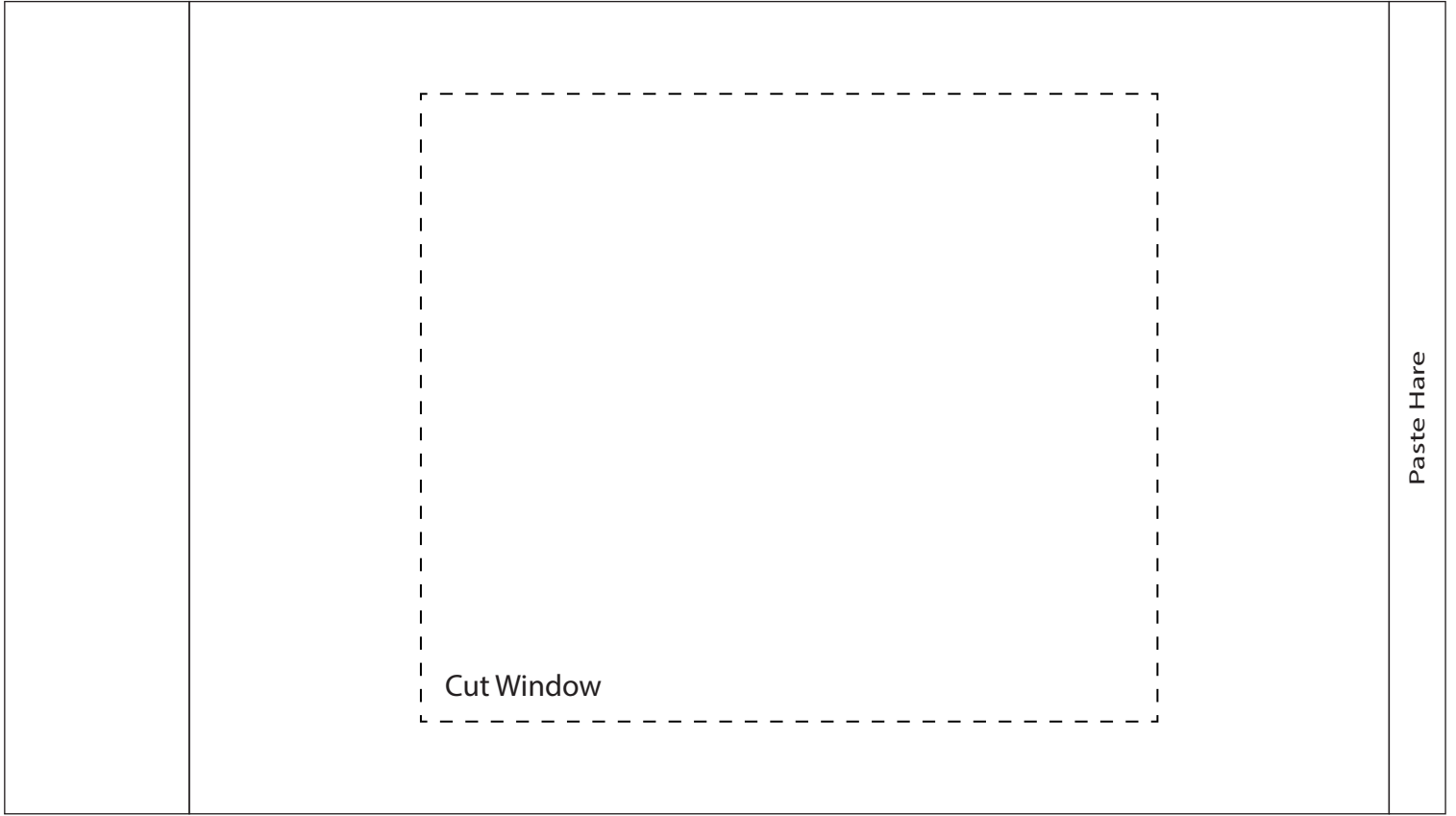

# INDIAN NATIONAL COSTUME GAME

LEVEL: MEDIUM

ESTIMATED TIME: 40 MINUTES

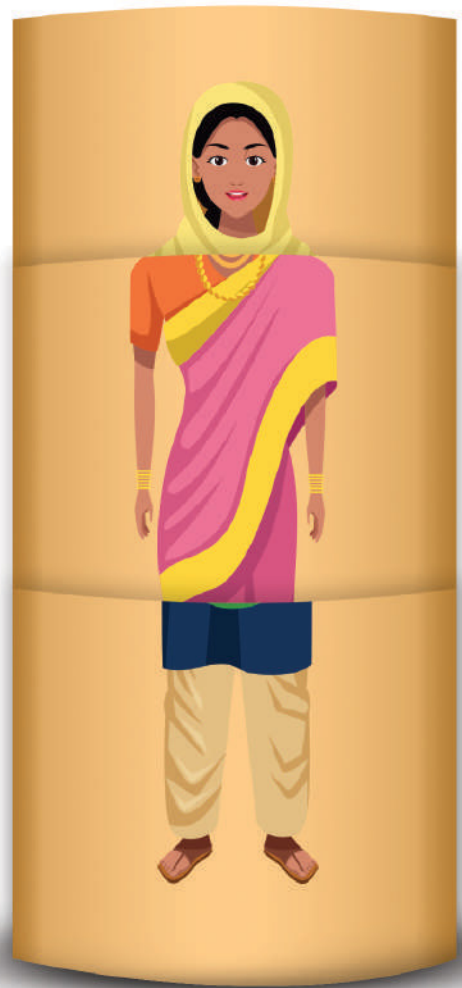
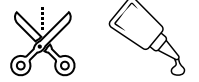

# Instructions

## Step 1:

Color the characters and the background.

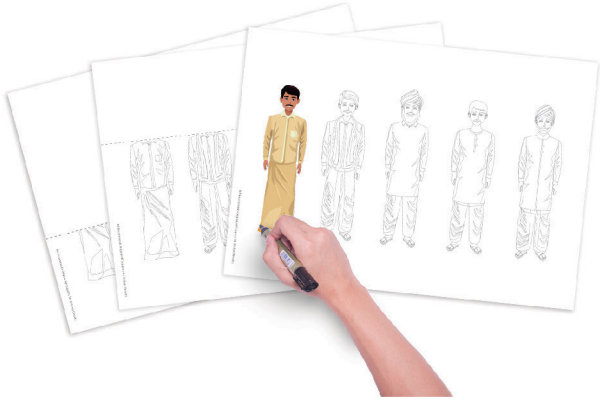

## Step 2:

Cut along the dotted line.



## Step 3:

Roll them up and paste the ends of the sheets.



## Step 4:

Arrange them over each other, as shown in the image.



## Step 5:

Spin the papers to create new characters.



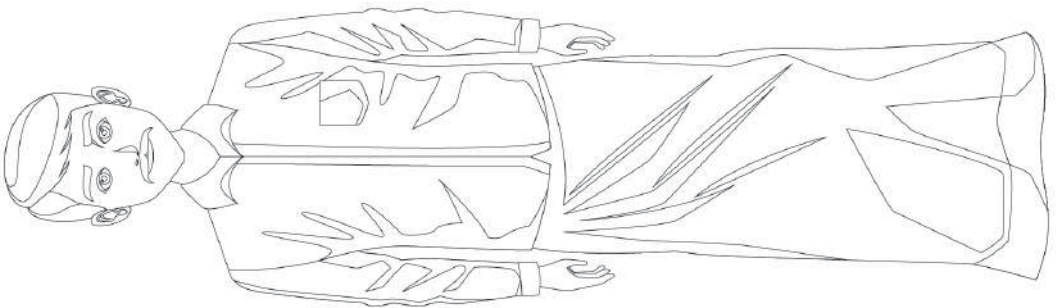
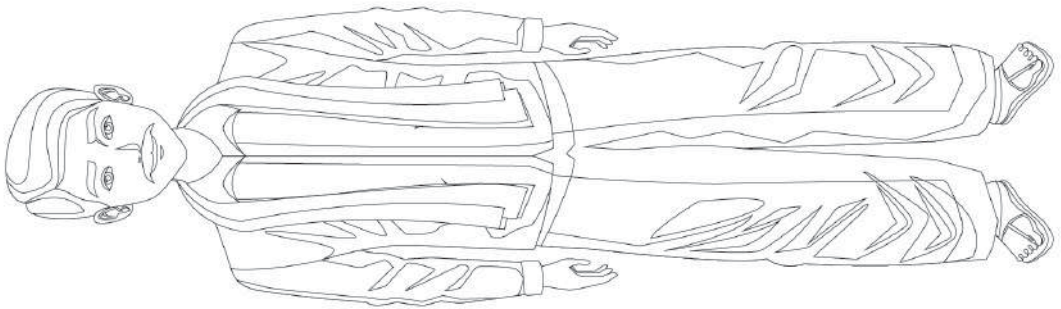
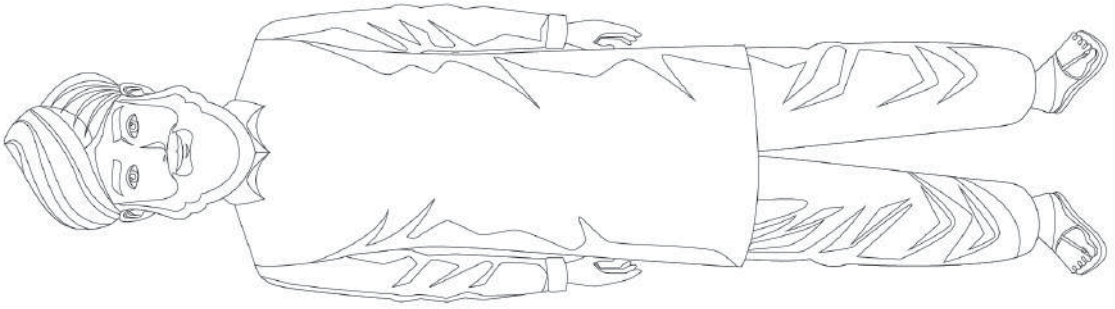
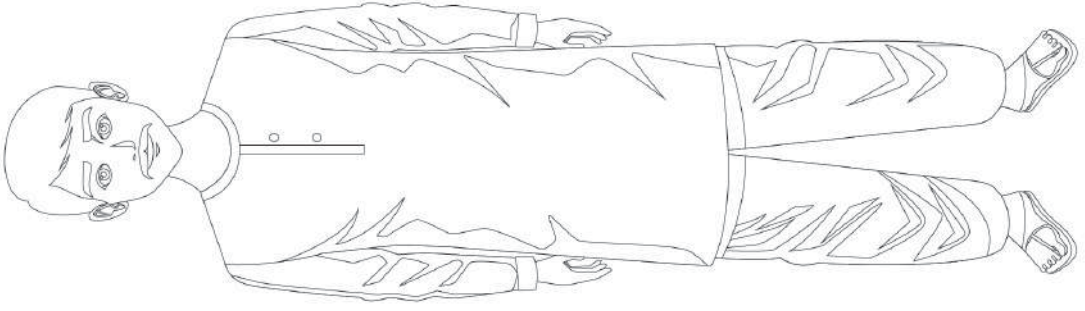
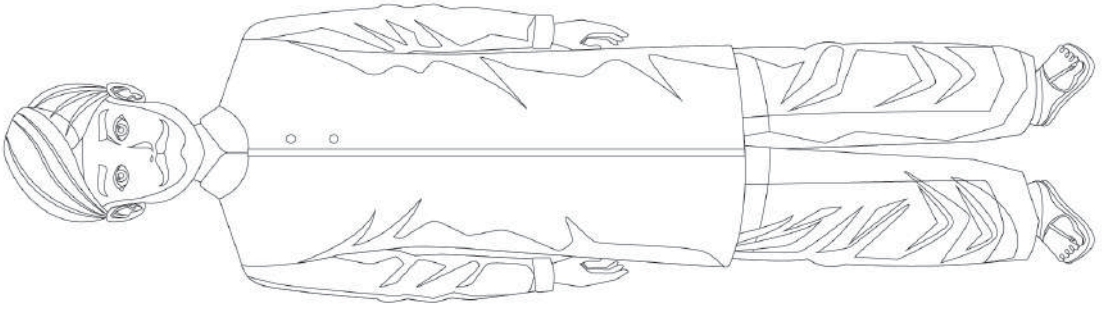

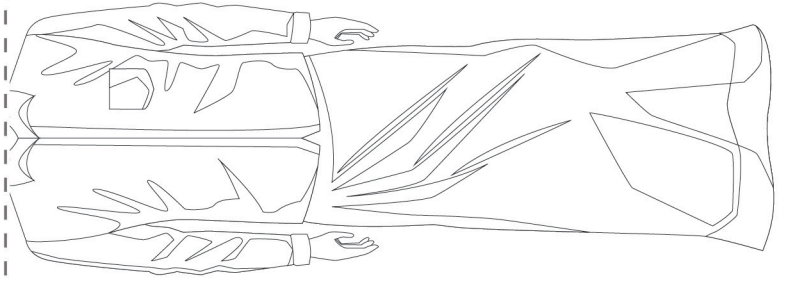
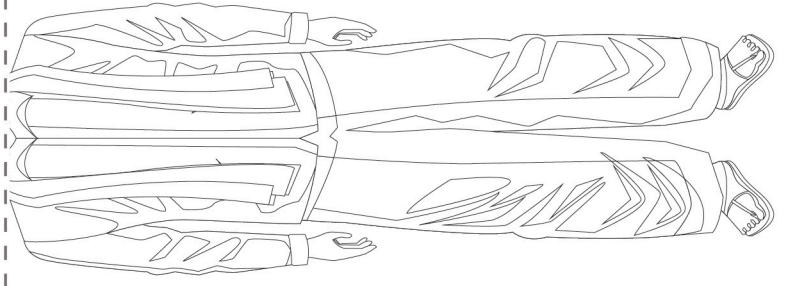
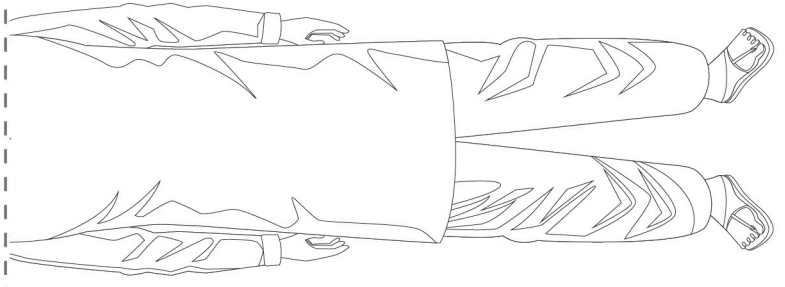
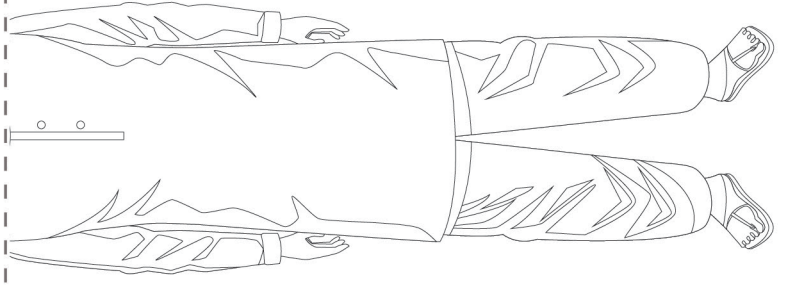
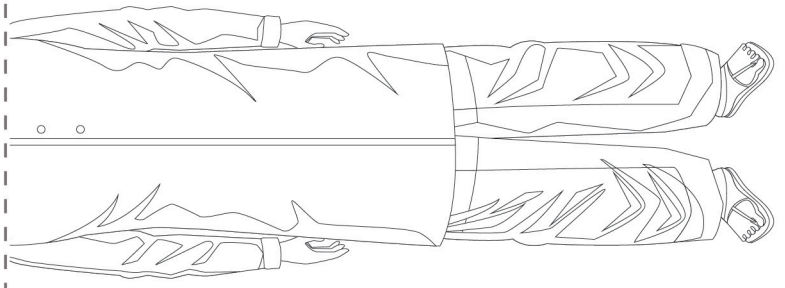

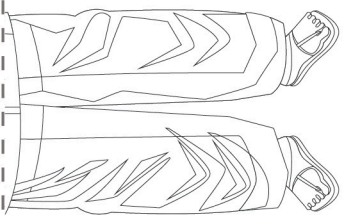
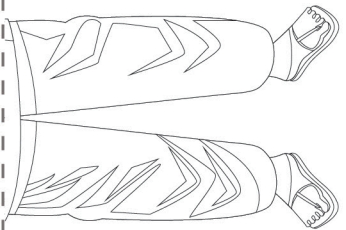
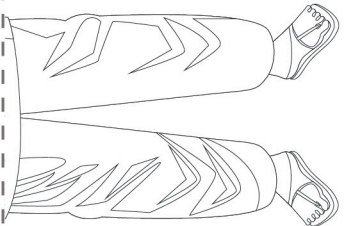
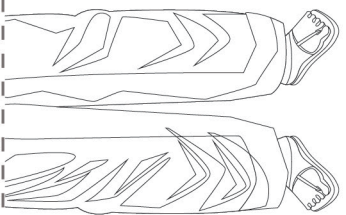
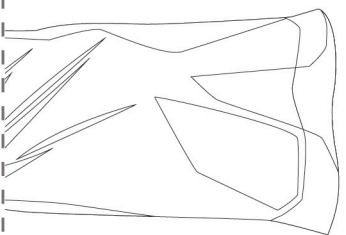

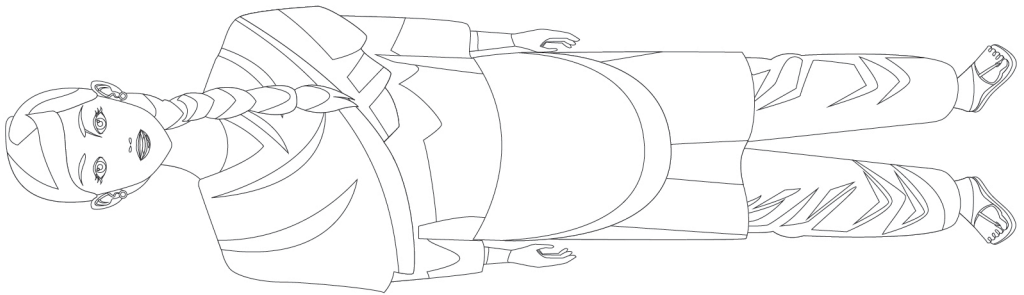
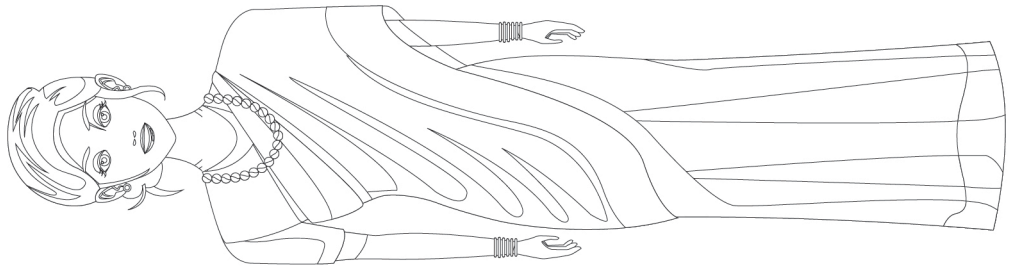
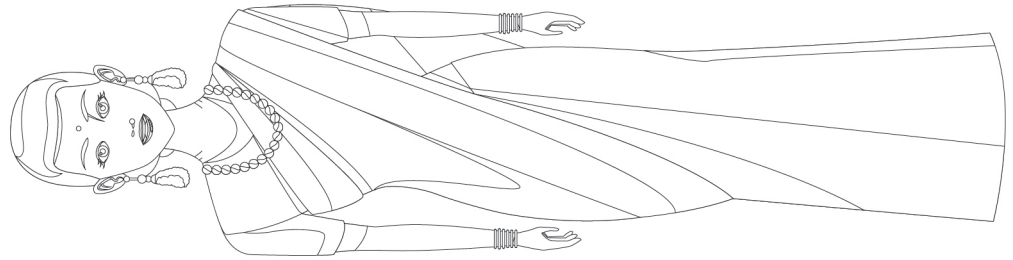
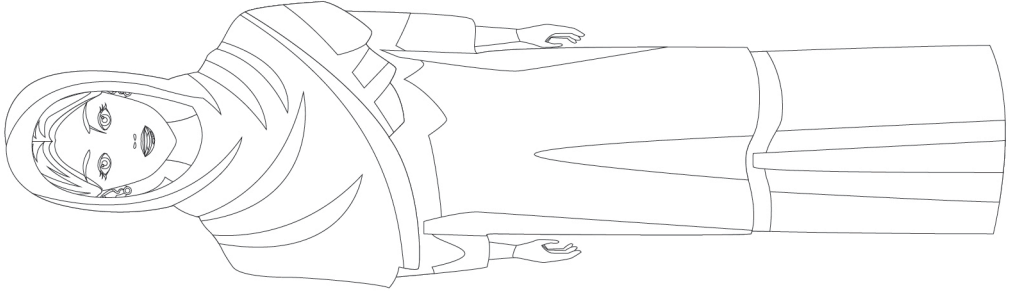
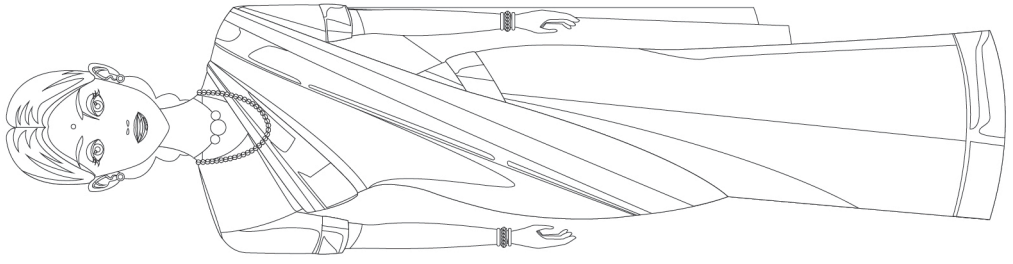

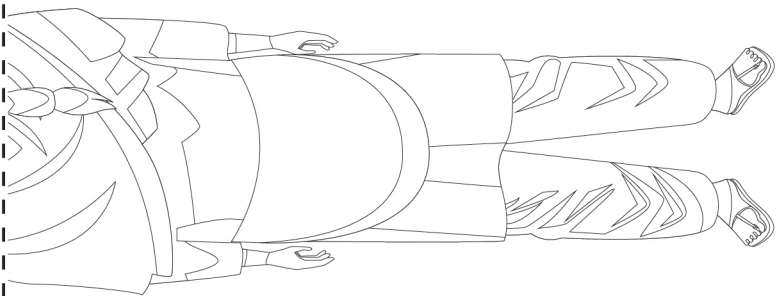
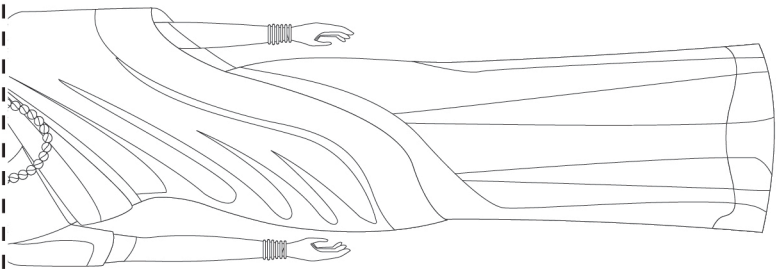
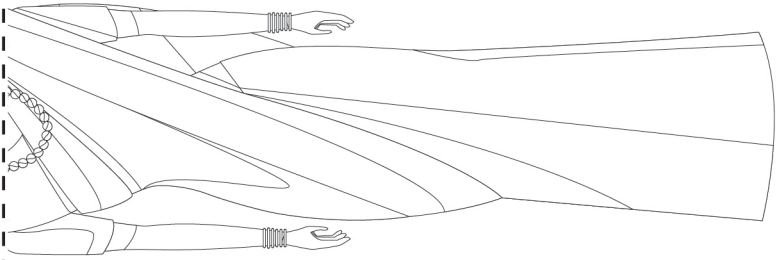
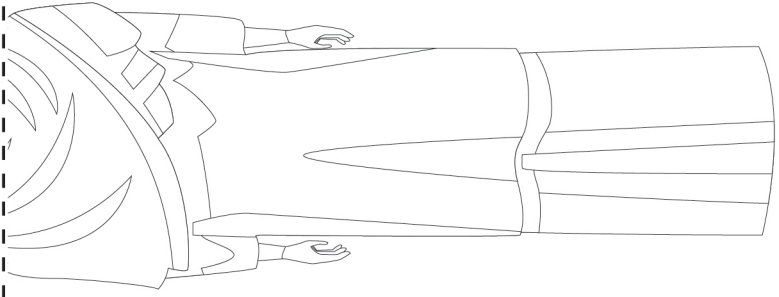
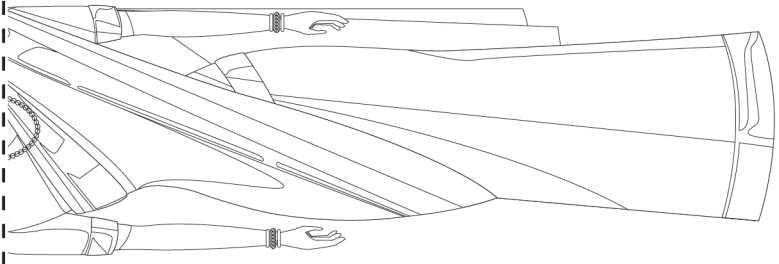

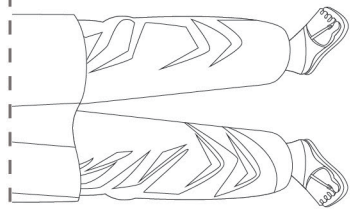
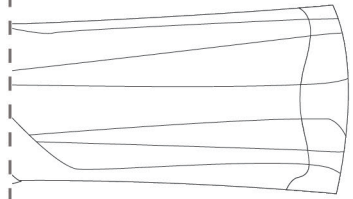
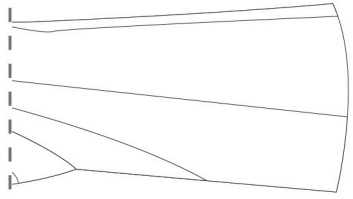
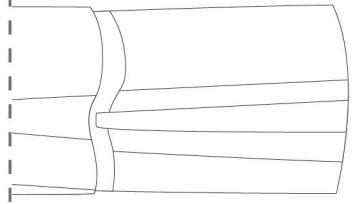
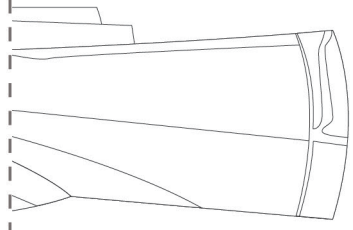

# CUT, COLOR, & CREATE YOUR NATIONAL ANIMAL BOOKMARK

LEVEL: EASY

ESTIMATED TIME: 15 MINUTES



Cut along the dotted line.

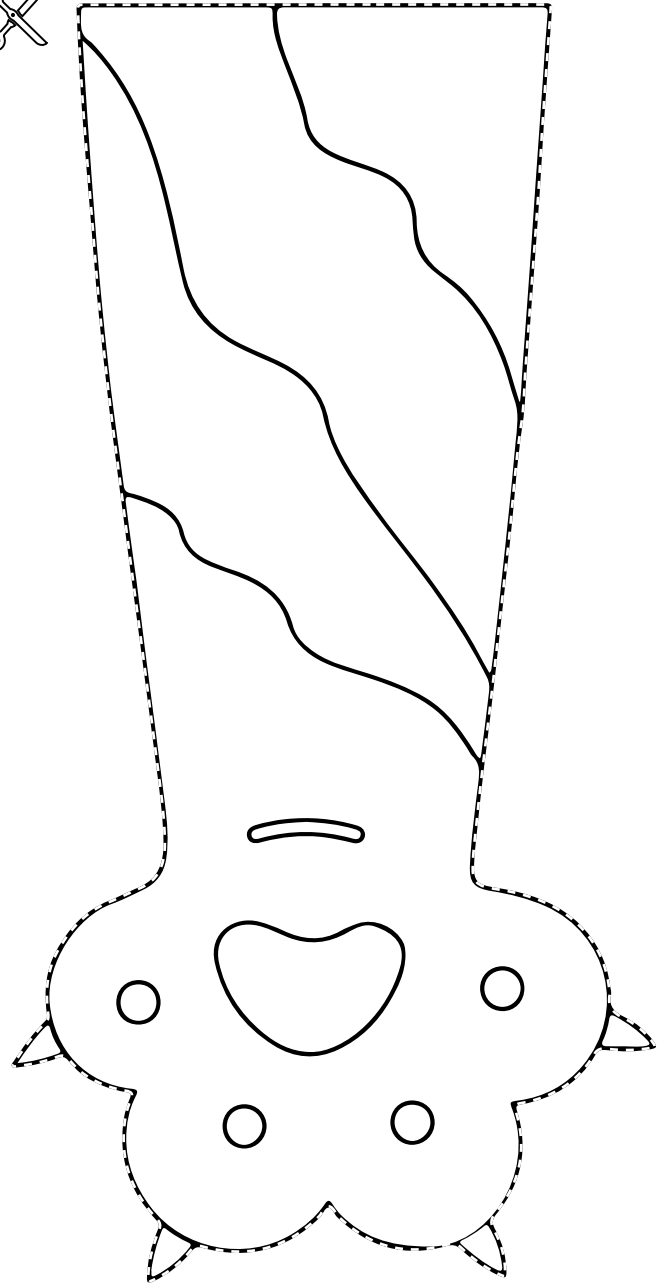
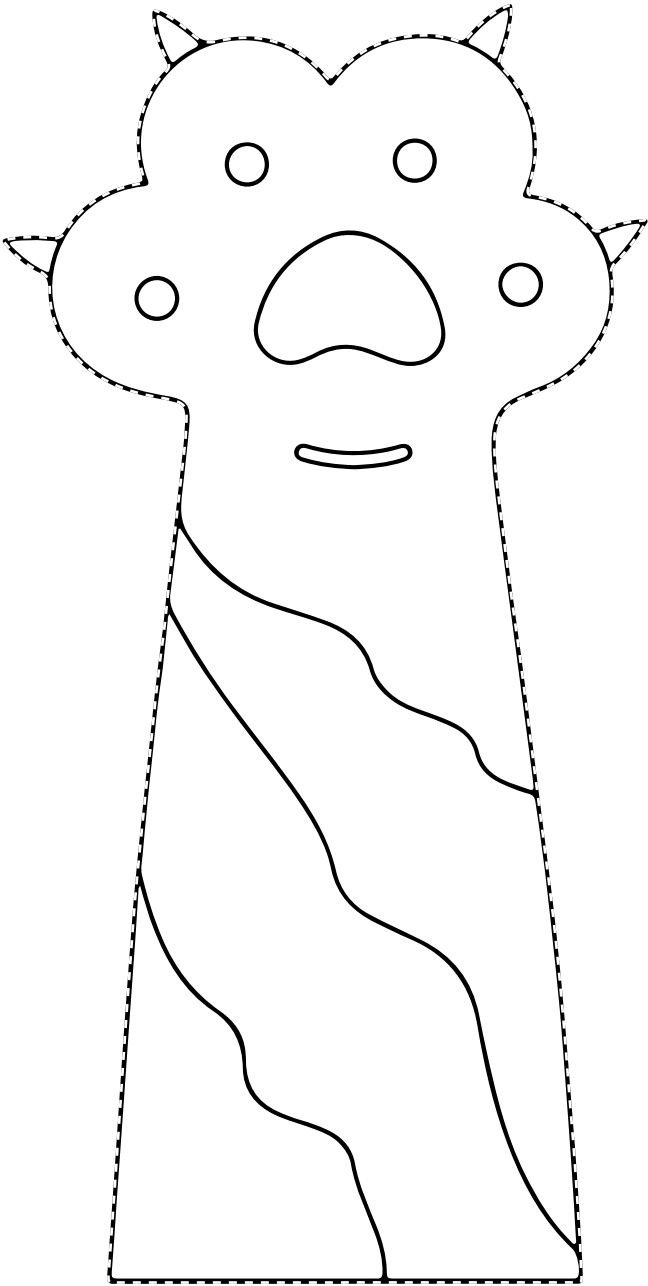

# UNITY CRAFT

LEVEL: MEDIUM

ESTIMATED TIME: 15 MINUTES

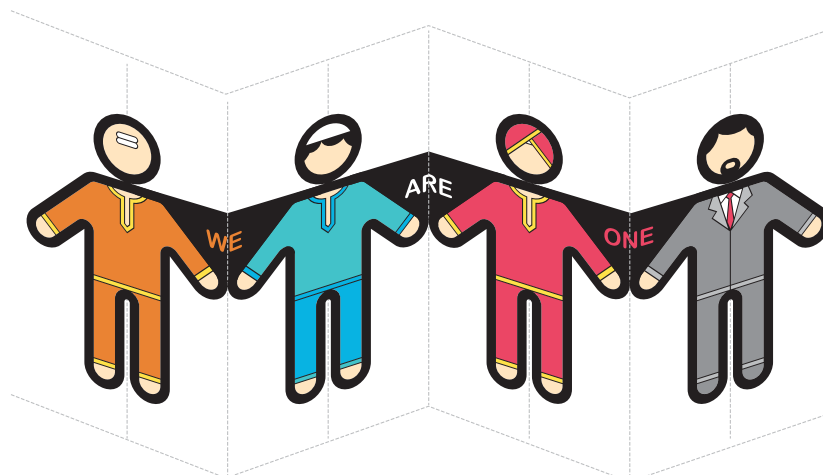
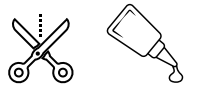

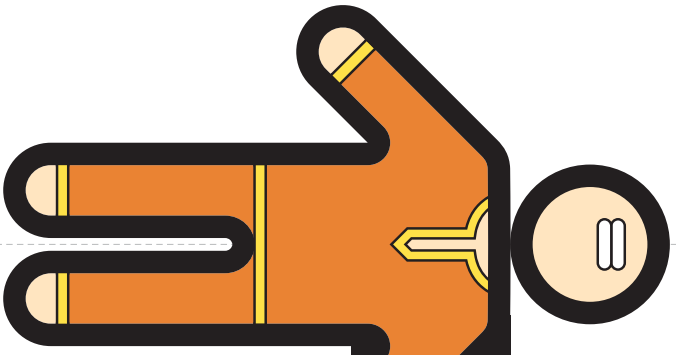
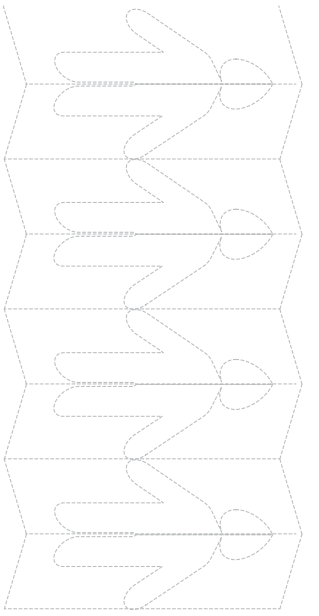

WE

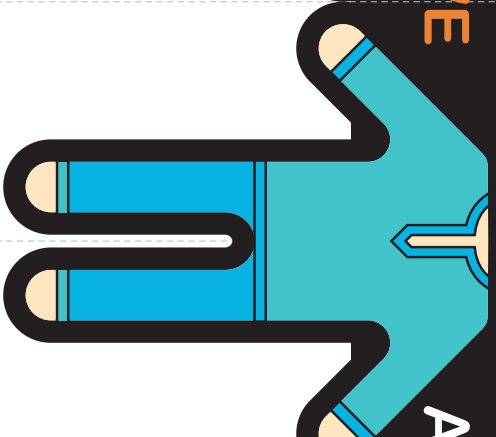

ARE

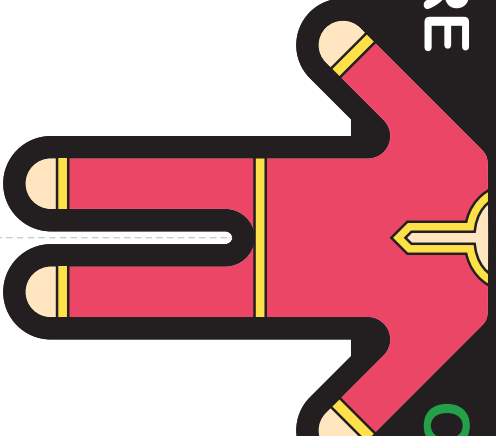

ONE

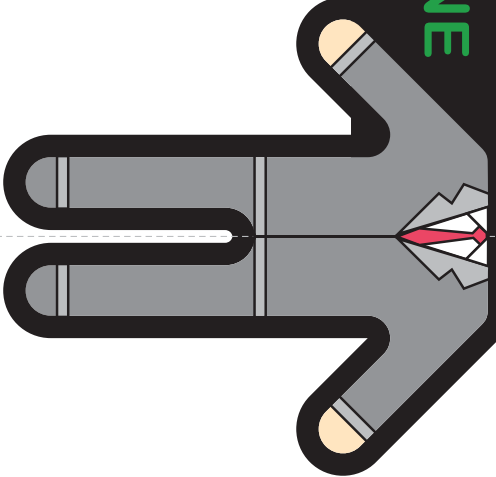

# HISTORY OF INDIAN FLAG

LEVEL: MEDIUM

ESTIMATED TIME: 30 MINUTES

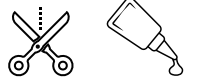

Everyone today knows what the Indian flag looks like. But did you know that our national flag went through 6 faces before we finally settled on our current one?

Get your colouring pens ready, and let's take a journey through the life of our national flag.

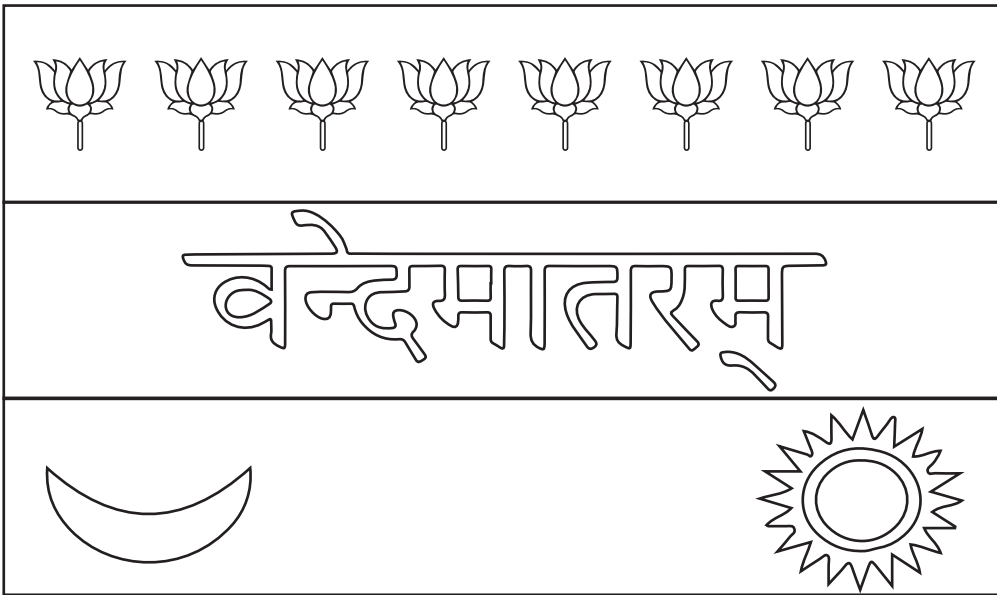

The first national flag in India was hoisted on August 7, 1906, in the Parsee Bagan Square (Green Park) in Kolkata.



The second flag was hoisted in Paris by Madame Cama in 1907. This was very similar to the first flag except that the top strip had only one lotus but seven stars denoting the Saptarishi.

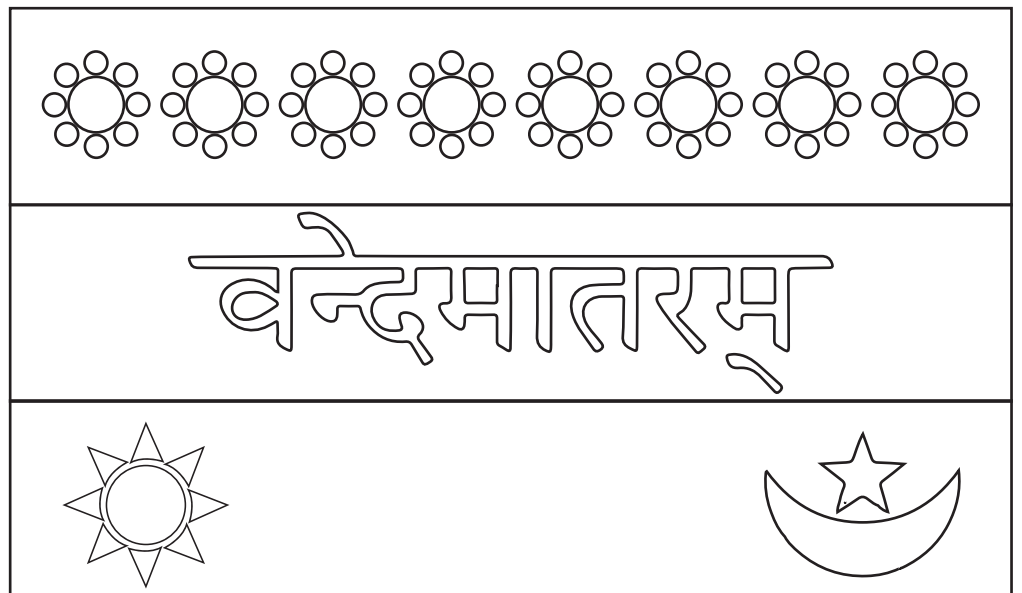

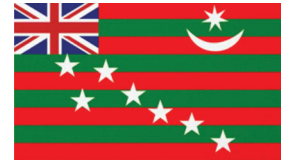
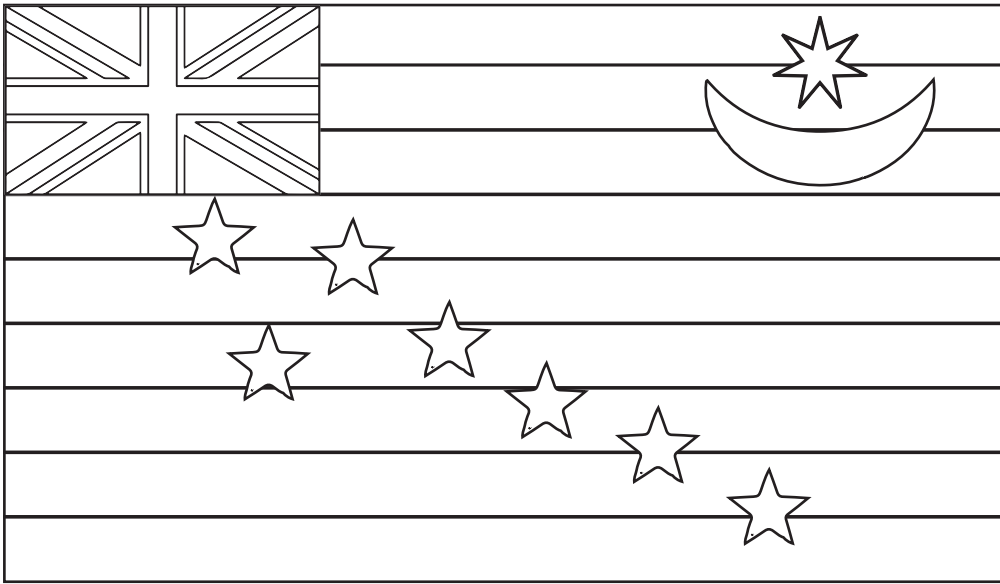

The third flag went up in 1917 when our political struggle had taken a definite turn. Dr. Annie Besant and Lokmanya Tilak hoisted it during the Home rule movement.

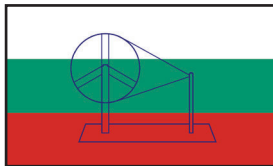

During the session of the All India Congress Committee at in 1921 in Vijayawada an Andhra youth prepared a flag and took it to Gandhiji. It was made up of two colours-red and green-representing the two major communities i.e. Hindus and Muslims.

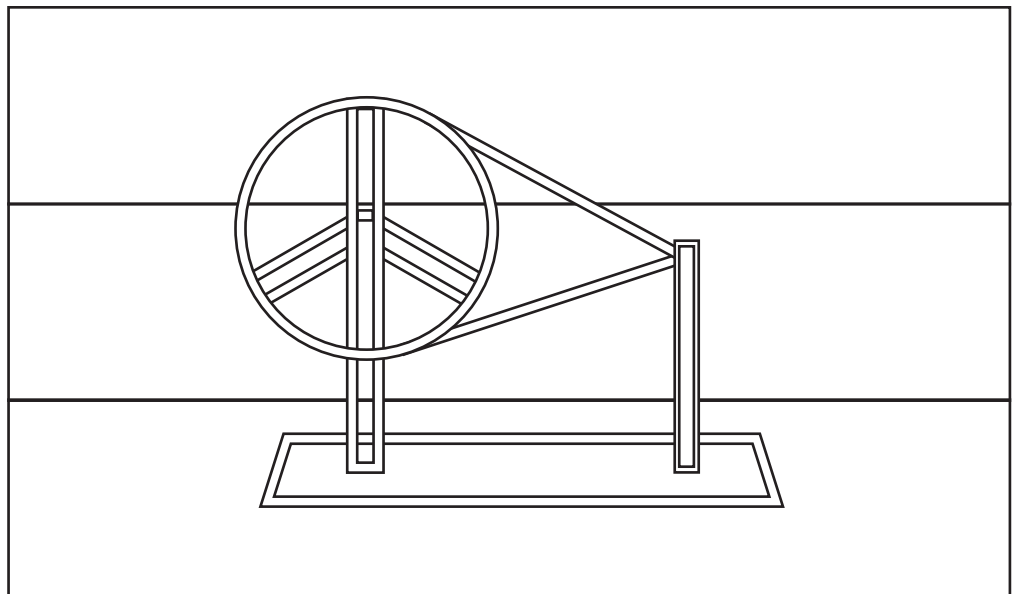

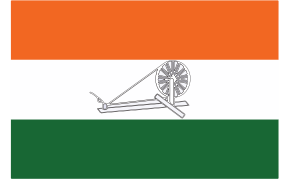
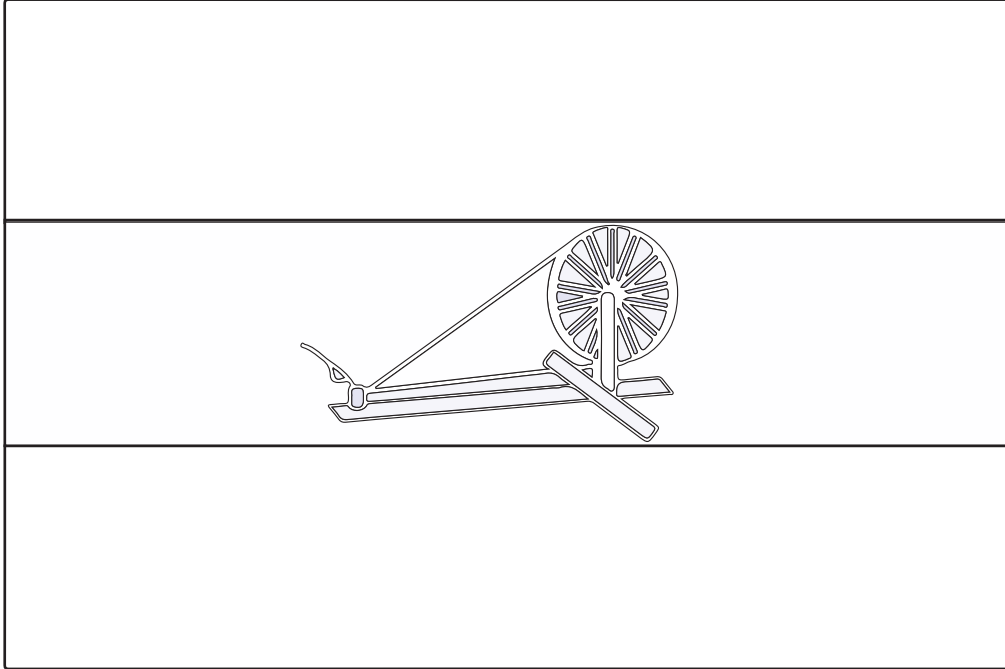

The year 1931 was a landmark in the history of the flag. A resolution was passed adopting a tricolor flag as our national flag.



On July 22, 1947, the Constituent Assembly adopted it as Free India National Flag. After Independence, the colors and their significance remained the same. Only the Dharma Charkha of Emperor Asoka was adopted in place of the spinning wheel as the emblem on the flag.

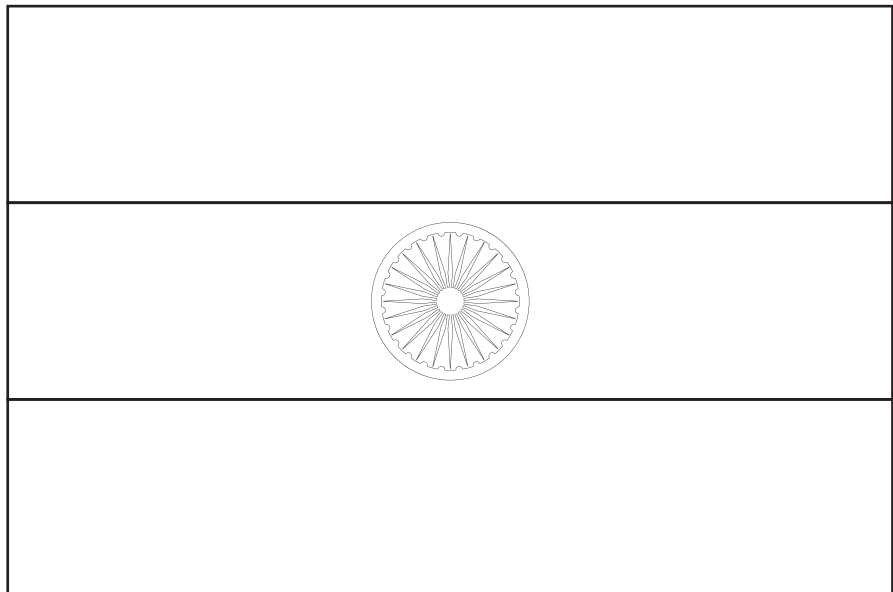

# BRING YOUR CHANDRAYAAN TO LIFE

LEVEL: MEDIUM

ESTIMATED TIME: 20 MINUTES

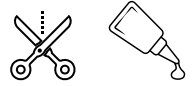

The name Chandrayaan means "Moon Craft" in ancient Sanskrit. Chandrayaan-1 was the first Indian lunar probe under Chandrayaan program. It was launched by the Indian Space Research Organisation (ISRO) in October 2008. Here's how to make your own Chandrayaan.

## STEP 1

Cut out, color and assemble your Chandrayaan by pasting different parts together.

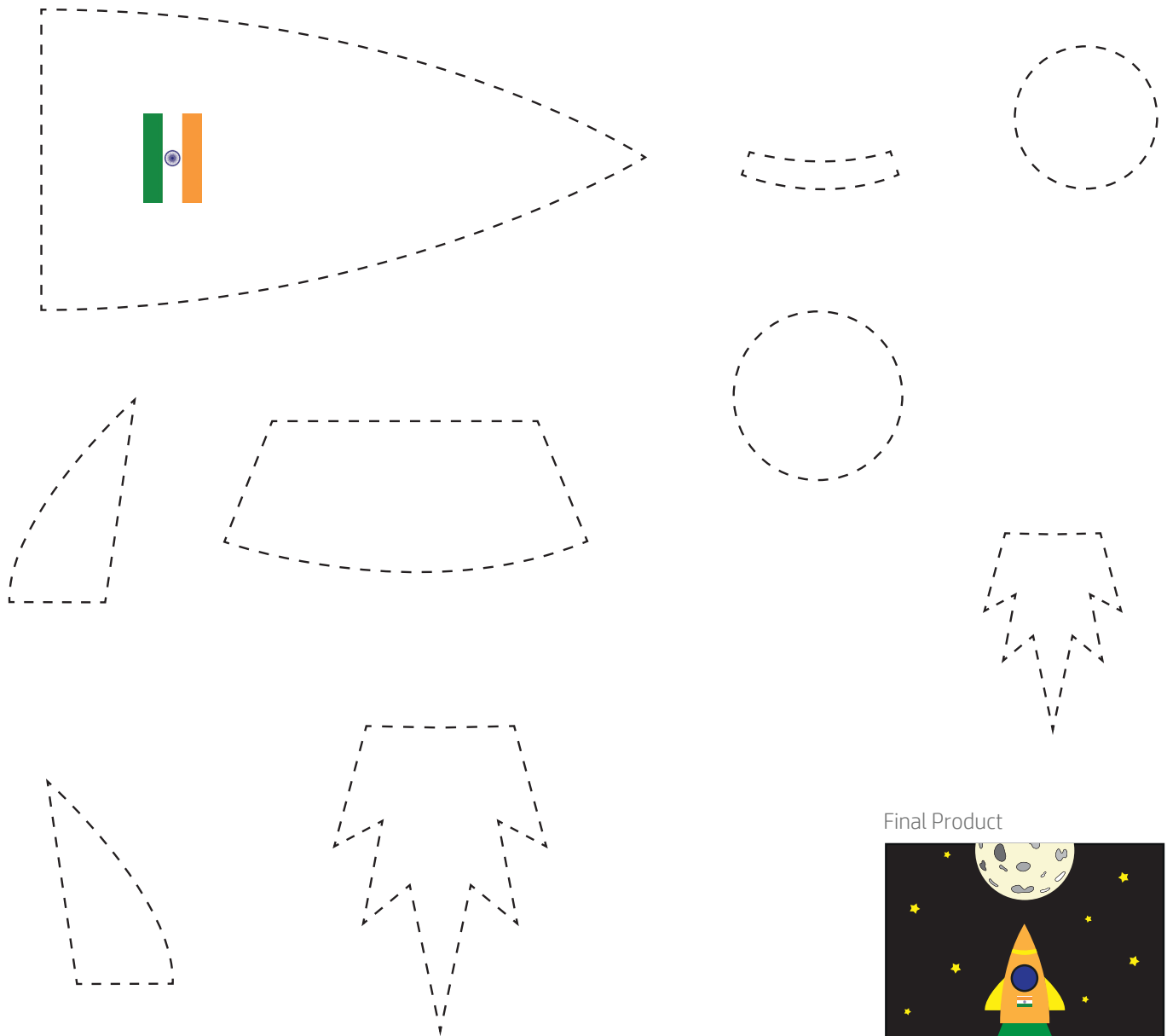

Final Product

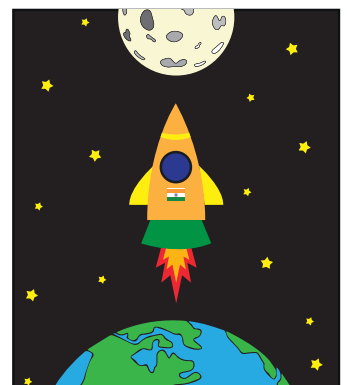

## STEP 2

Color the moon, earth, and space. Stick your Chandrayaan in the middle. Cut the final drawing along the dotted line and enjoy the journey to the moon and back!

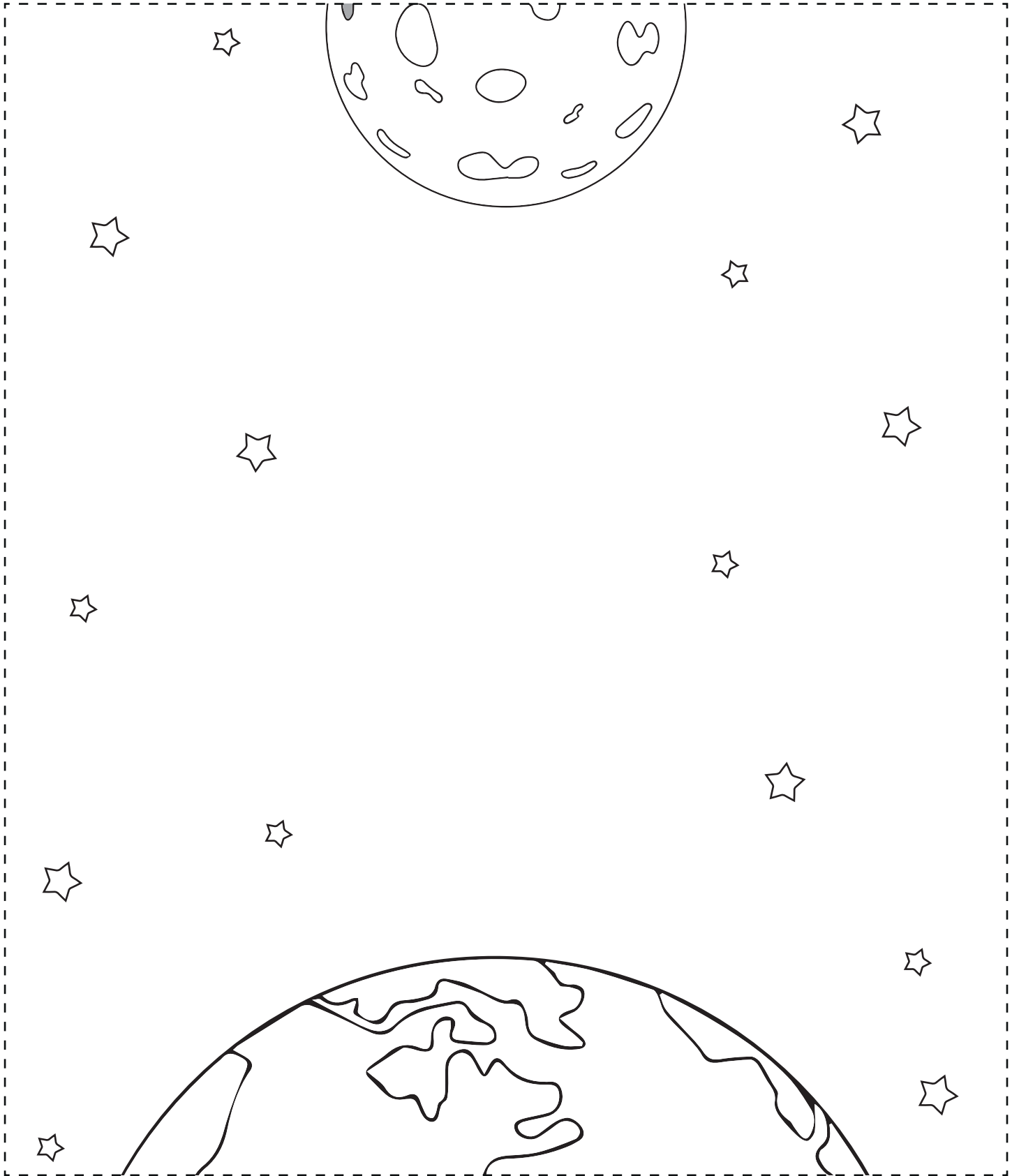

# CREATE YOUR OWN INDIA STAMP

LEVEL: MEDIUM

ESTIMATED TIME: 20 MINUTES

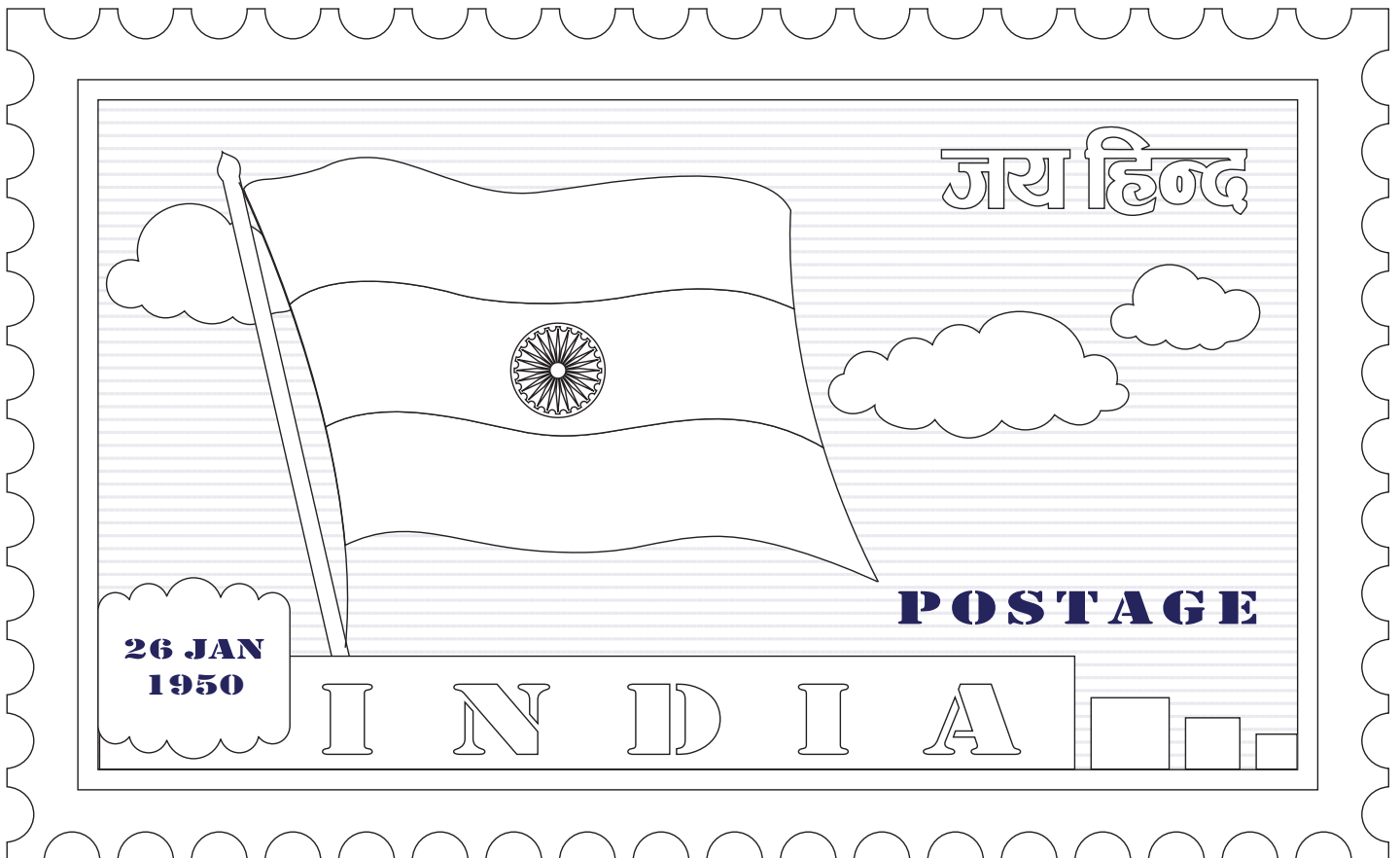
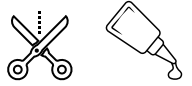

# COLOR THE PARADE POSTER

LEVEL: MEDIUM

ESTIMATED TIME: 30 MINUTES

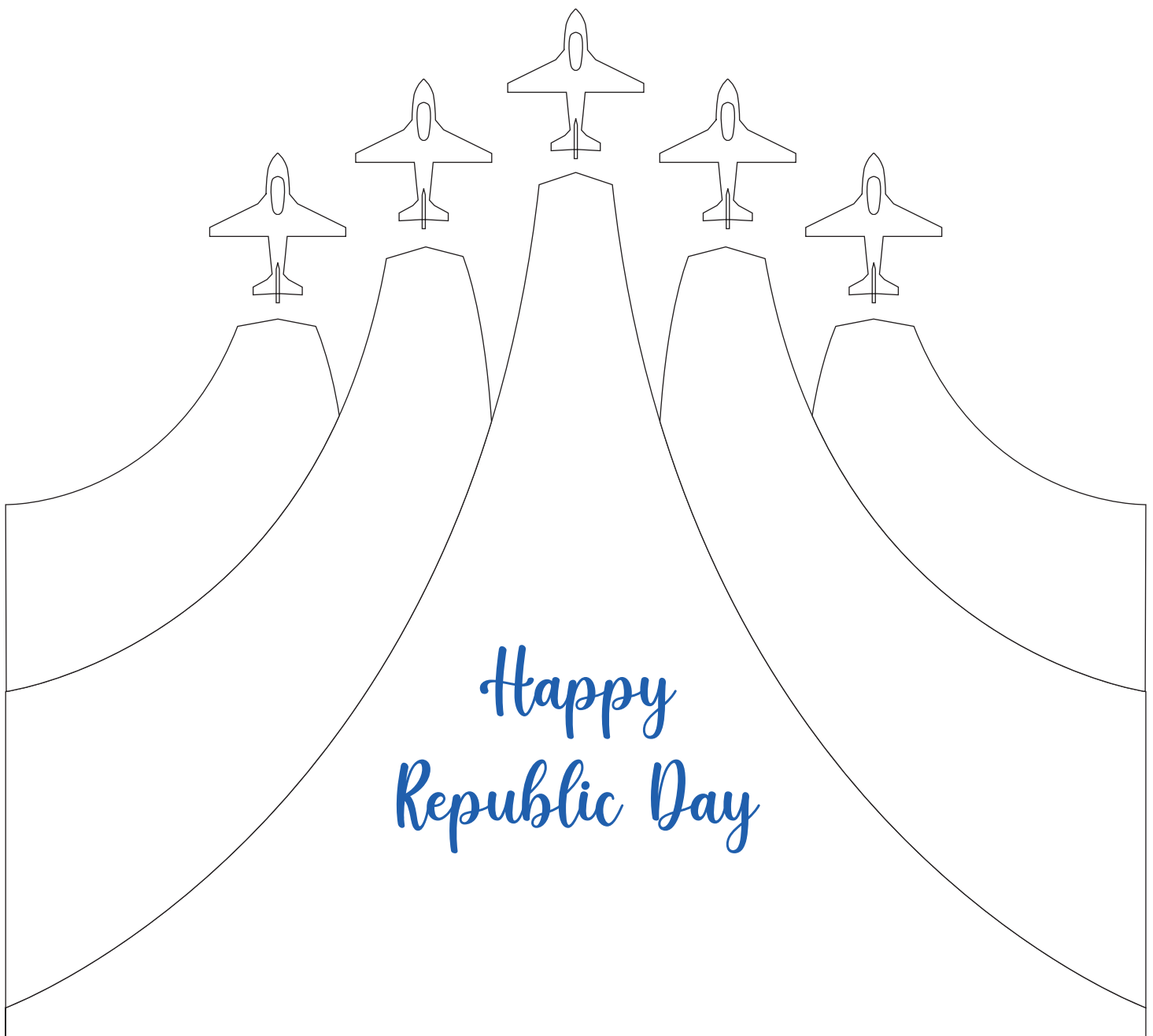
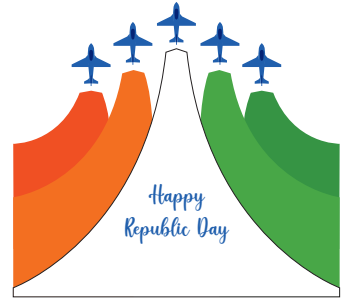
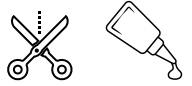

# MATCH THE INDIAN MONUMENTS

LEVEL: MEDIUM

ESTIMATED TIME: 30 MINUTES

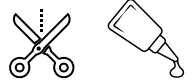

Fill the colors and match the following images with numbers



\* LOTUS TEMPLE



\* TAJ MAHAL



\* MANDALA



\* RED FORT



\* GOLDEN TEMPLE



\* VICTORIA MEMORIAL



\* BENGAL TIGER



COBRA



\* SAMSARA



\* INDIAN SPICES



\* GATEWAY OF INDIA



\* INDIAN ELEPHANT

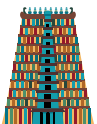

\* MEENAKSHI AMMAN TEMPLE



\* INDIAN WATER JUG



\* CHENNAI RAILWAY STATION



\* VIDHANA SOUDHA



# BRING THE CELEBRATIONS TO LIFE

LEVEL: MEDIUM

ESTIMATED TIME: 30 MINUTES

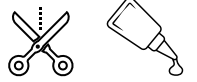

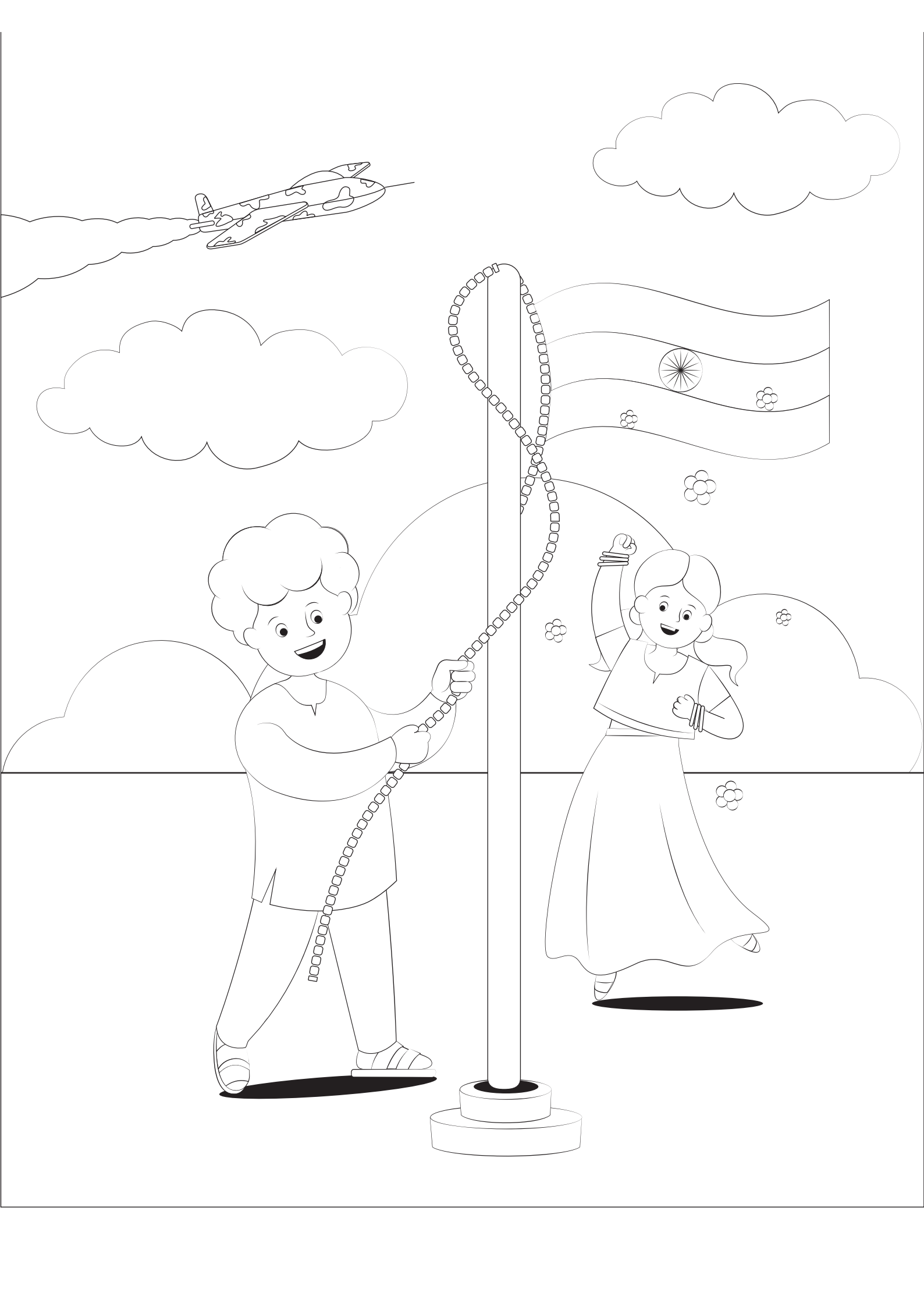

# BRING THE CELEBRATIONS TO LIFE

LEVEL: MEDIUM

ESTIMATED TIME: 30 MINUTES



This is just an example of how the flag and the boy will look like. Color your own flag and the boy.

# JOIN THE DOTS TO CREATE OUR MAP

LEVEL: MEDIUM

ESTIMATED TIME: 30 MINUTES

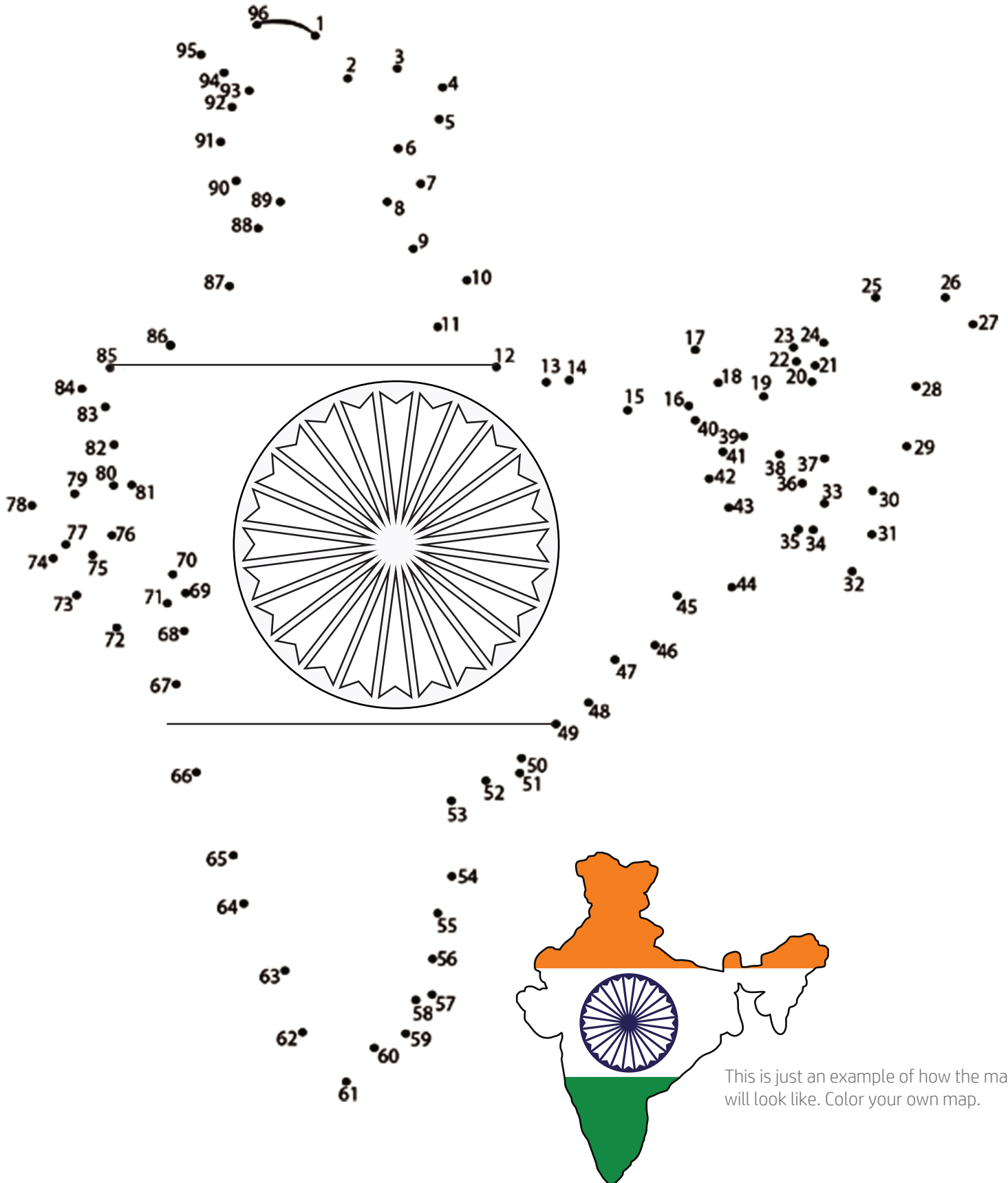
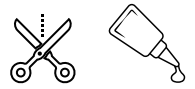

This is just an example of how the map will look like. Color your own map.

BRING THE CELEBRATIONS TO LIFE

LEVEL: MEDIUM

ESTIMATED TIME: 30 MINUTES

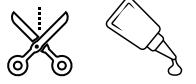

# Happy Republic Day!



BRING THE CELEBRATIONS TO LIFE

LEVEL: MEDIUM

ESTIMATED TIME: 30 MINUTES

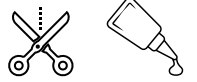

Rejoice in beautiful freedom.  
**Happy Republic Day!**

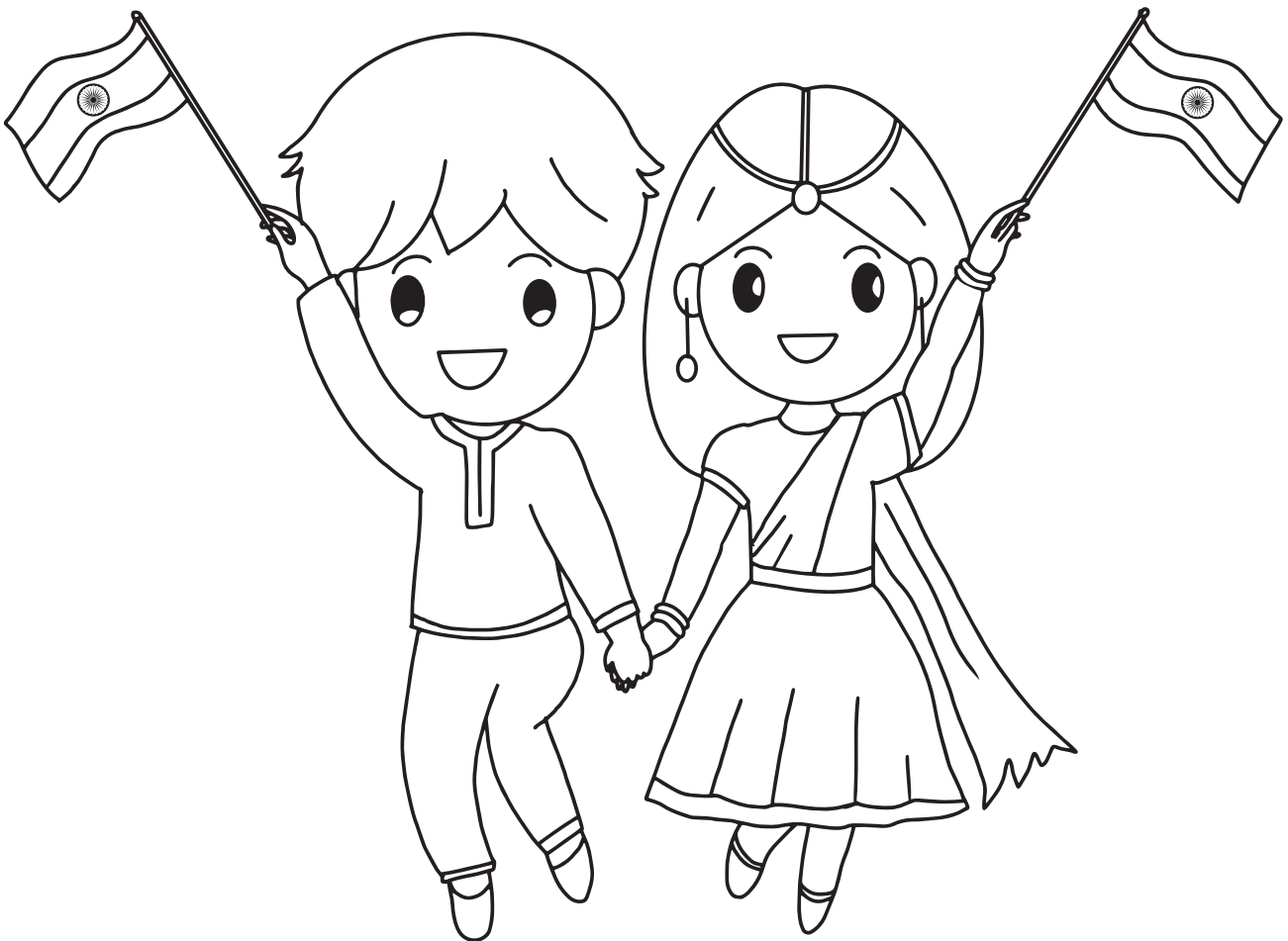

BRING THE CELEBRATIONS TO LIFE

LEVEL: MEDIUM

ESTIMATED TIME: 30 MINUTES



# Happy Republic Day!

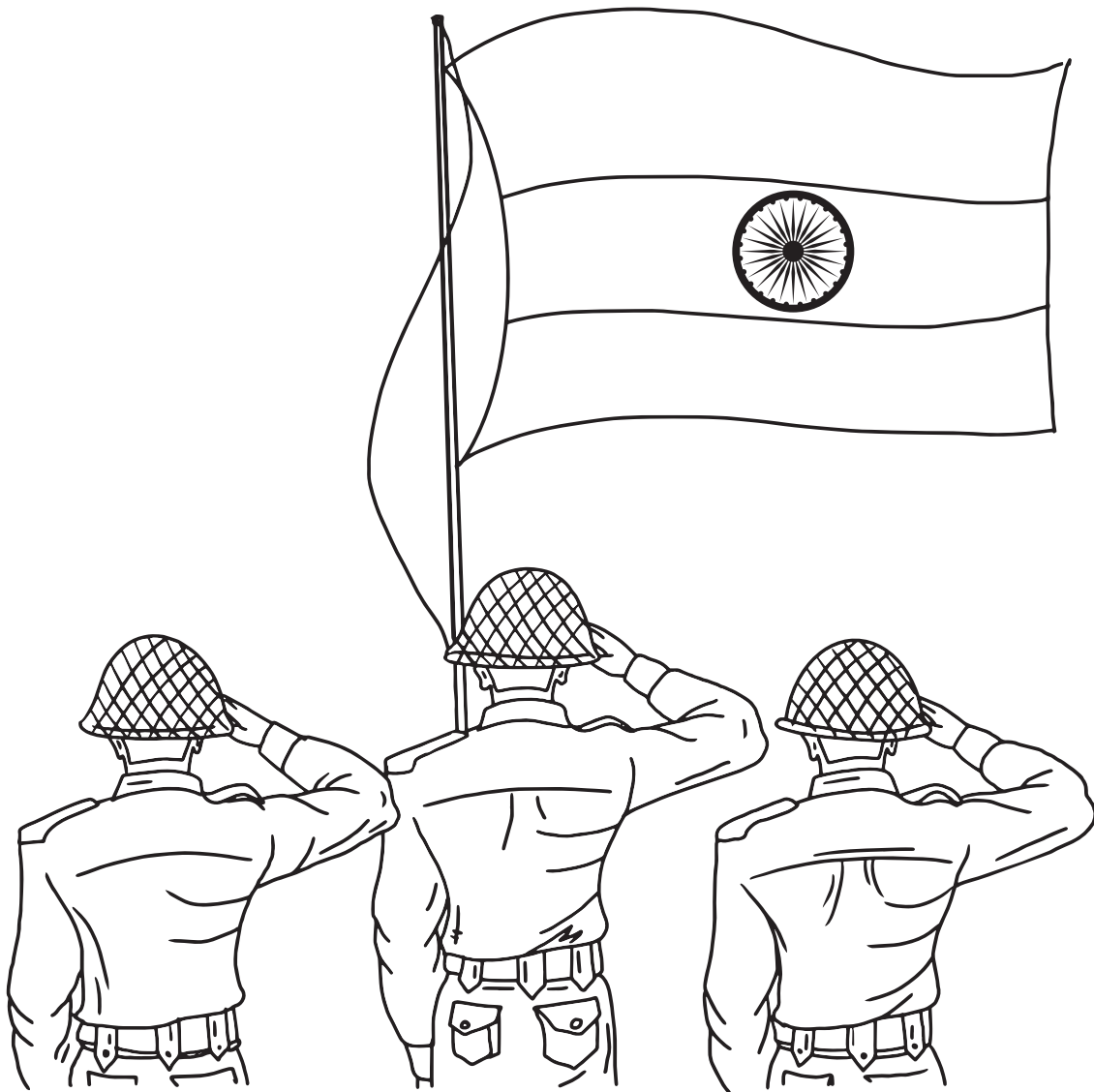

# BRING THE CELEBRATIONS TO LIFE

LEVEL: MEDIUM

ESTIMATED TIME: 30 MINUTES

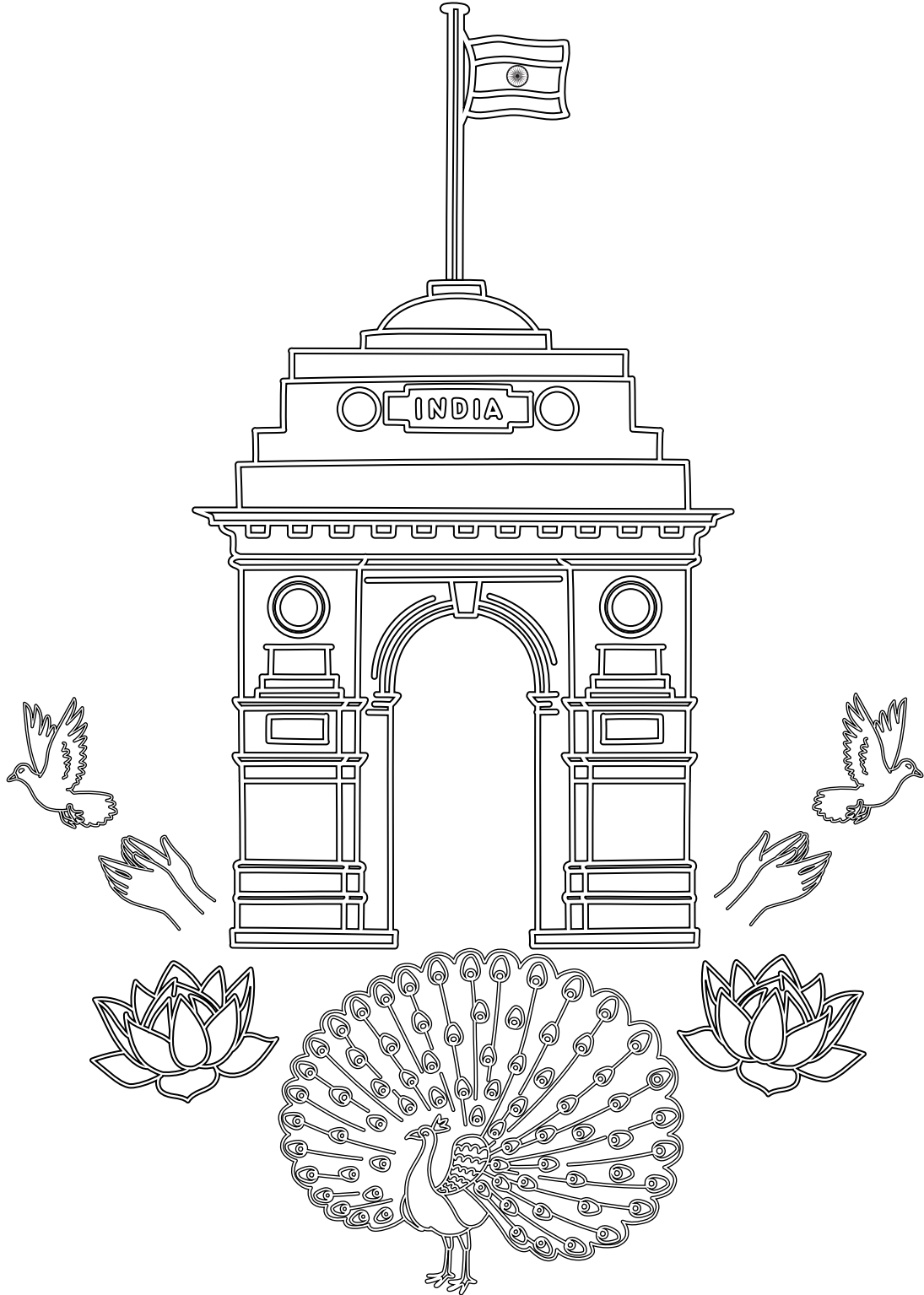

## Happy Republic Day!

# BRING THE CELEBRATIONS TO LIFE

LEVEL: MEDIUM

ESTIMATED TIME: 30 MINUTES

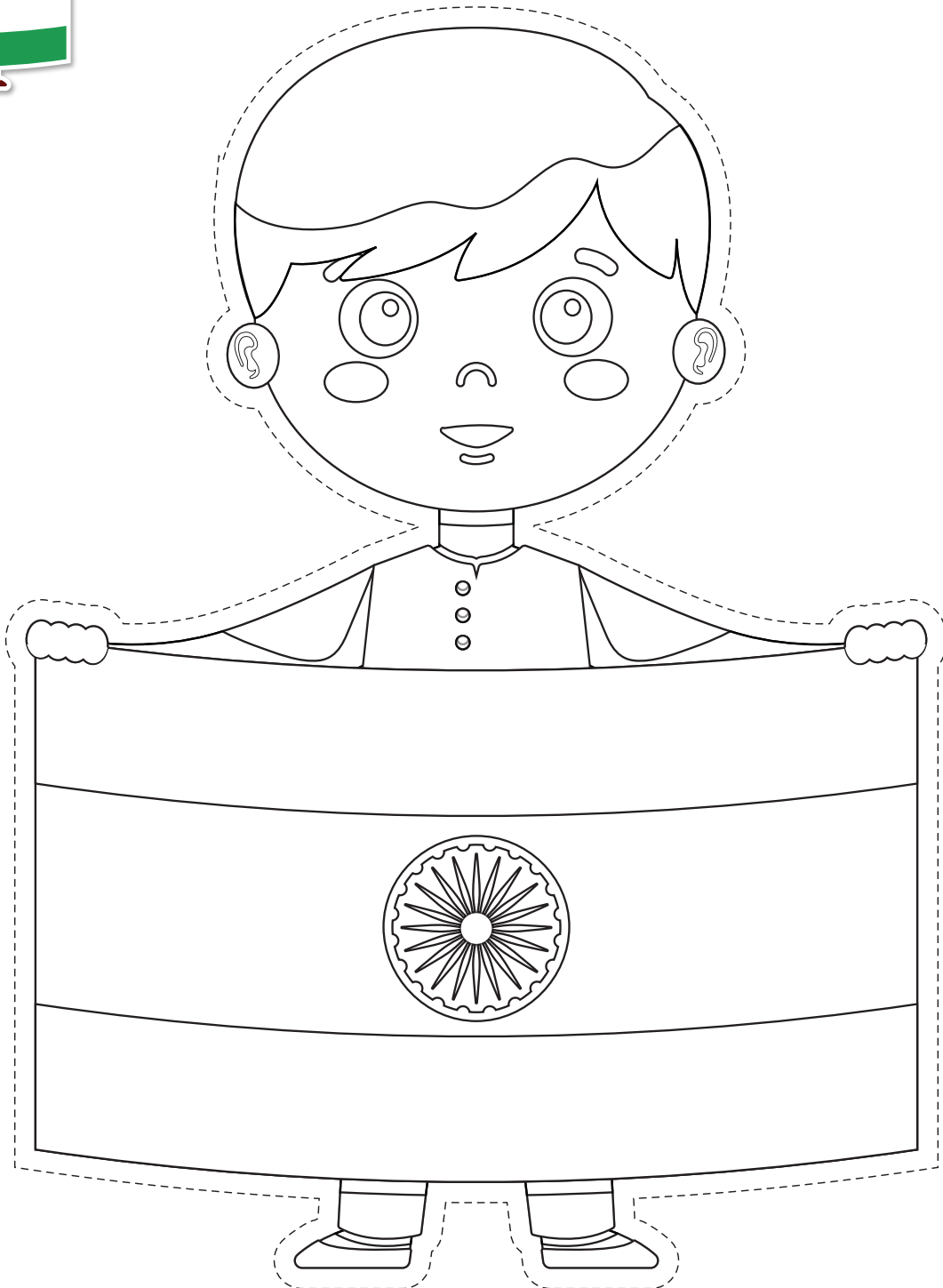
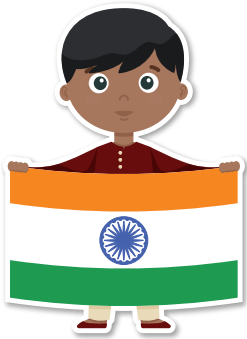
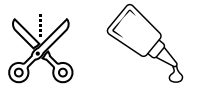

# MAKE YOUR OWN REPUBLIC DAY CARD

LEVEL: MEDIUM

ESTIMATED TIME: 30 MINUTES

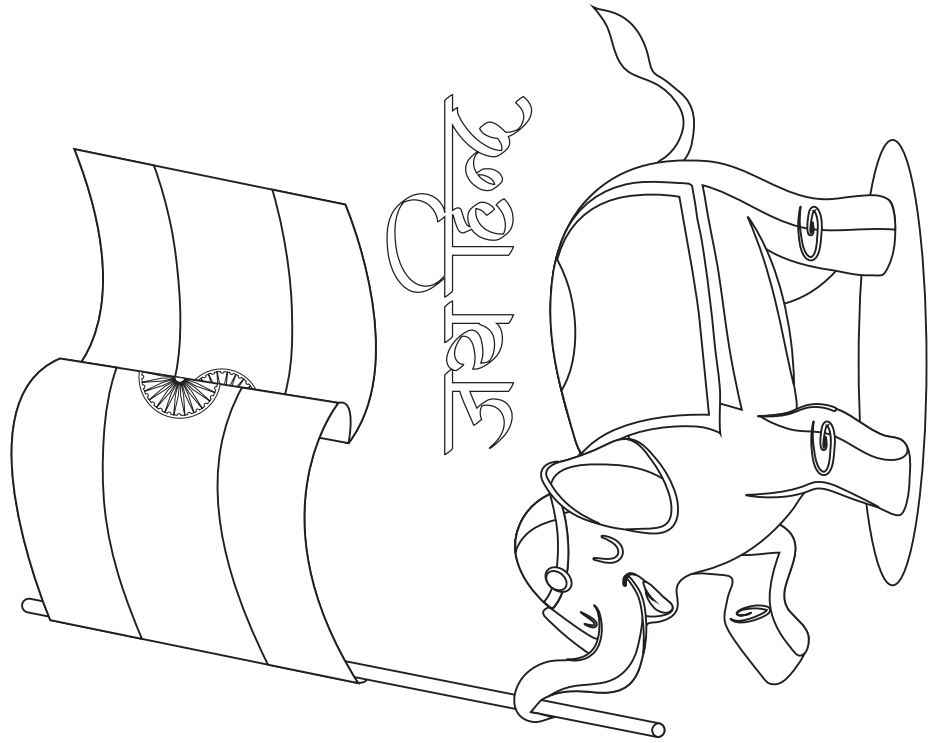

FOLD HERE

# BRING THE CELEBRATIONS TO LIFE

LEVEL: MEDIUM

ESTIMATED TIME: 30 MINUTES

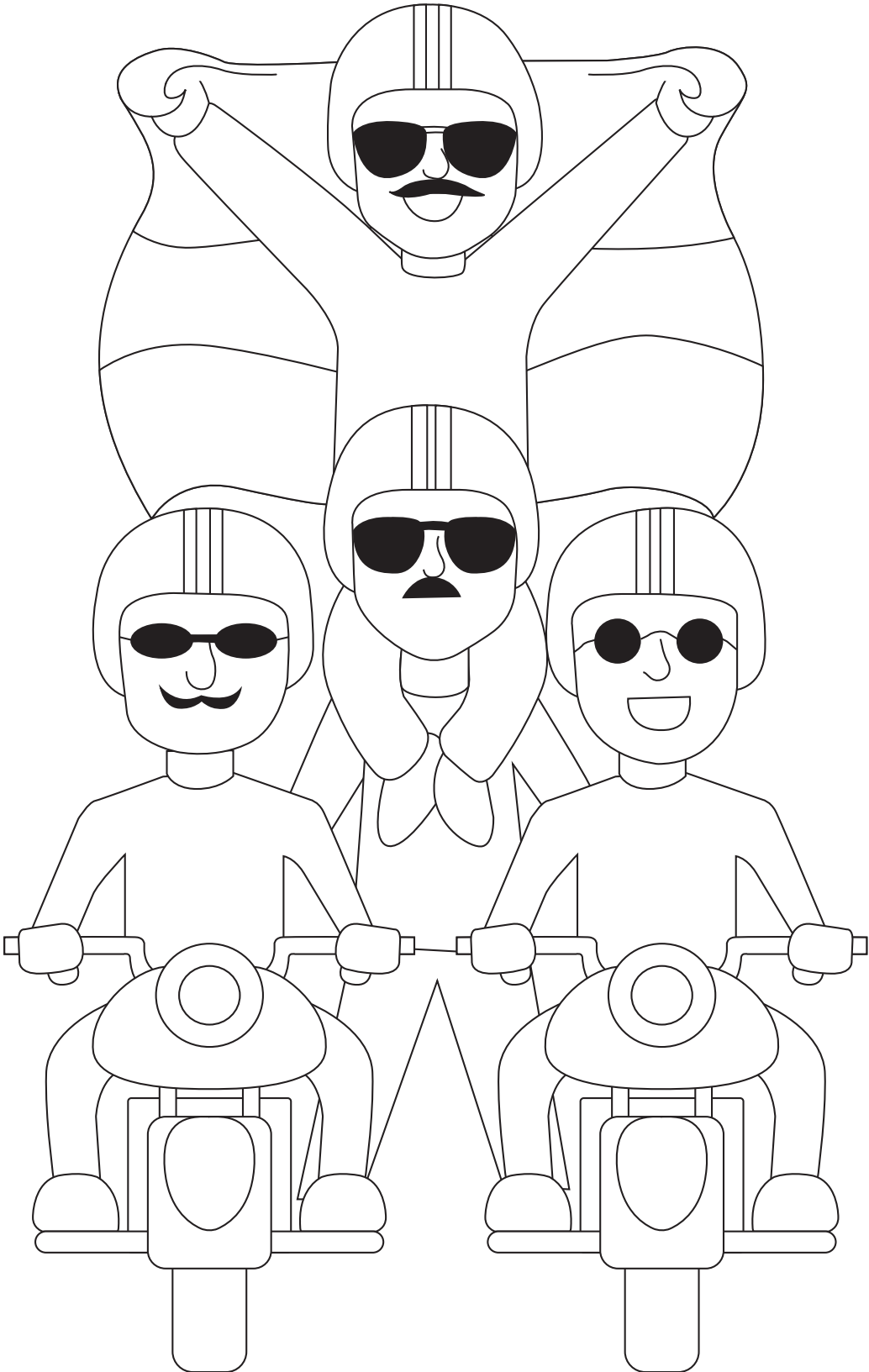
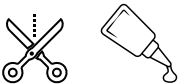

# MAKE YOUR TRICOLOR BADGE

LEVEL: MEDIUM

ESTIMATED TIME: 30 MINUTES

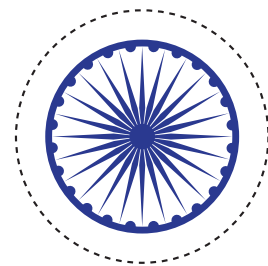
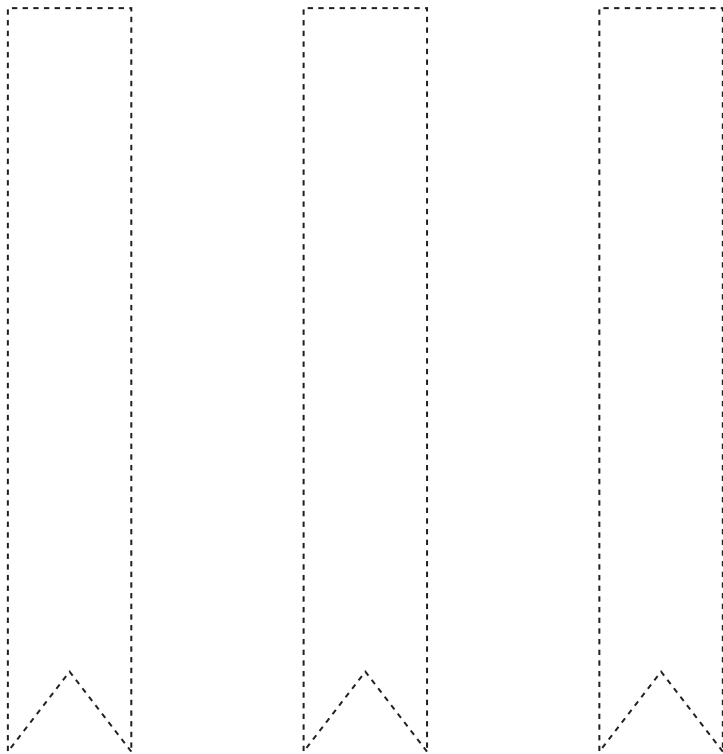
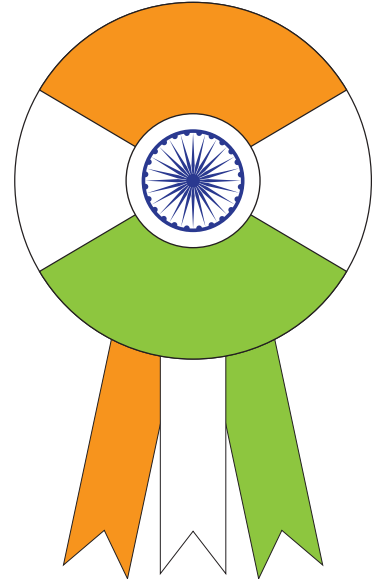
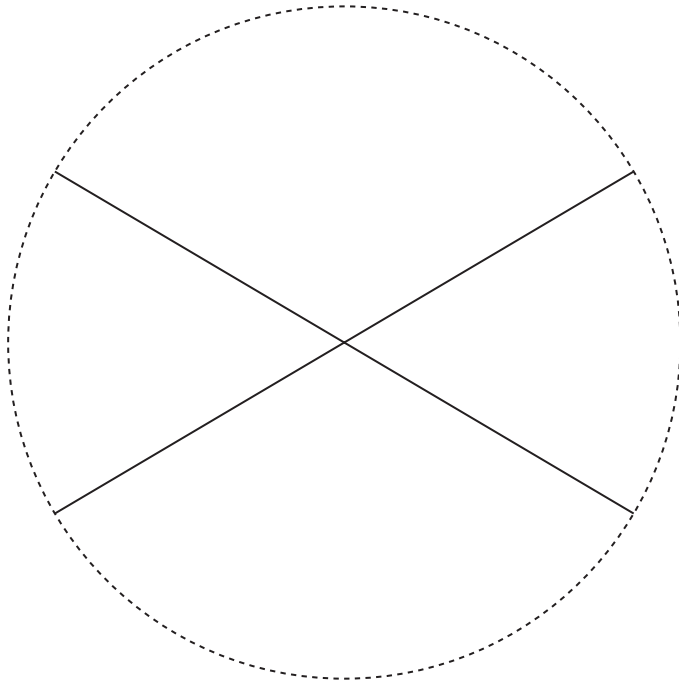
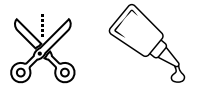

# MAKE YOUR TRICOLOR BADGE

LEVEL: MEDIUM

ESTIMATED TIME: 30 MINUTES

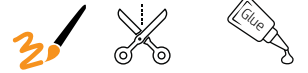

## Instructions

Step 1:  
Cut all the images along the dotted lines and color.

Step 2:  
Arrange all the three flower-shaped drawings and paste them, as shown in the mock-up visual.

Step 3:  
Paste the Ashoka wheel in the middle and the tri-color stripes at the bottom.

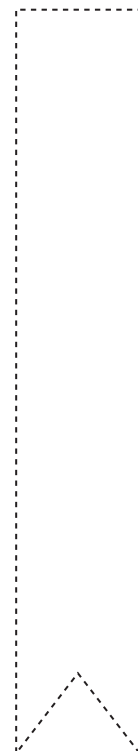
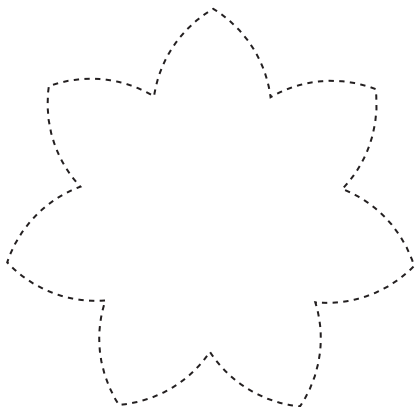
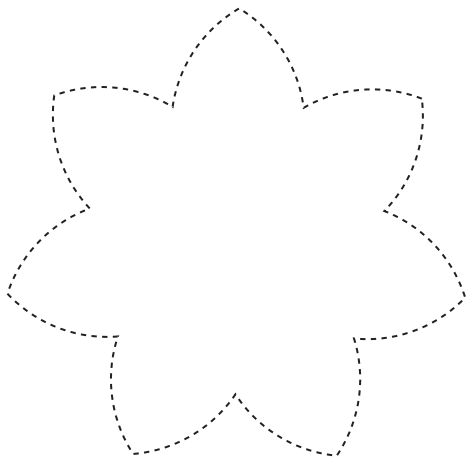
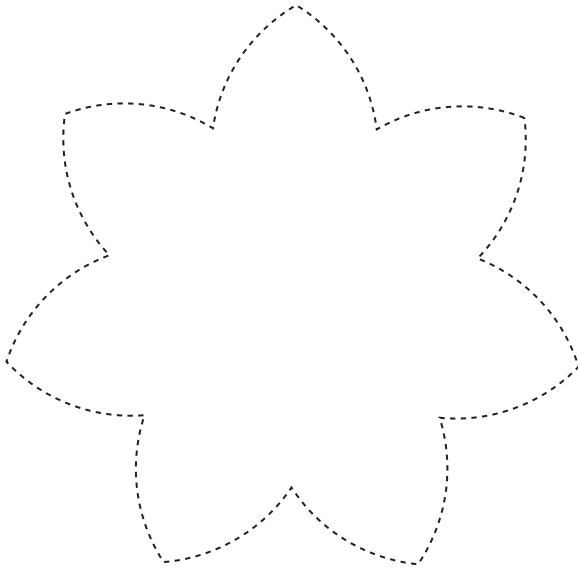

# COLOR THE BALOONS

LEVEL: MEDIUM

ESTIMATED TIME: 30 MINUTES

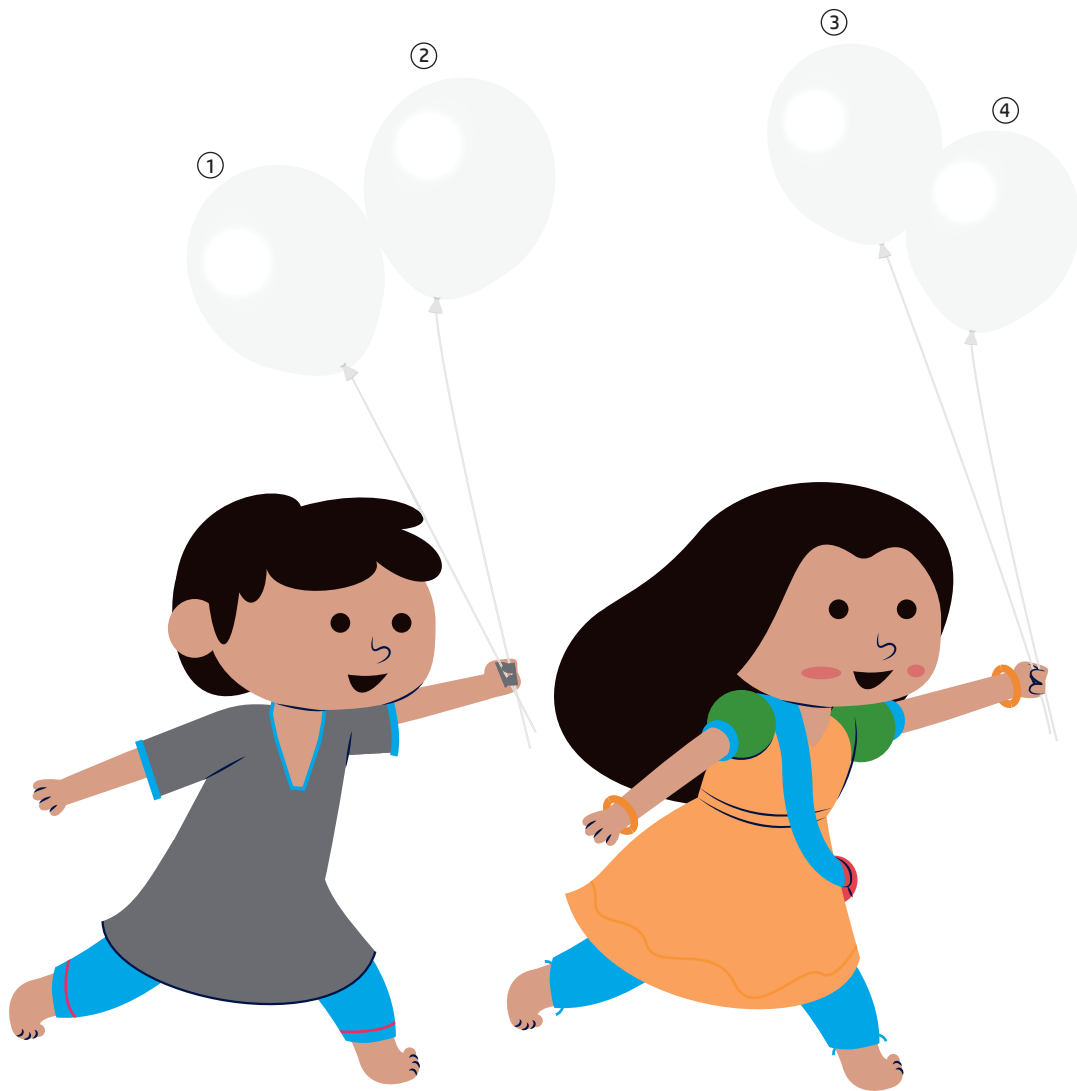

SAFFRON

①

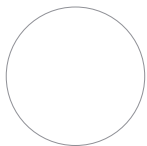

WHITE

② ③

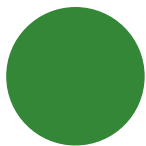

GREEN

④



# COLOR THE NATIONAL BIRD OF INDIA- PEACOCK

LEVEL: MEDIUM

ESTIMATED TIME: 30 MINUTES

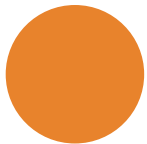
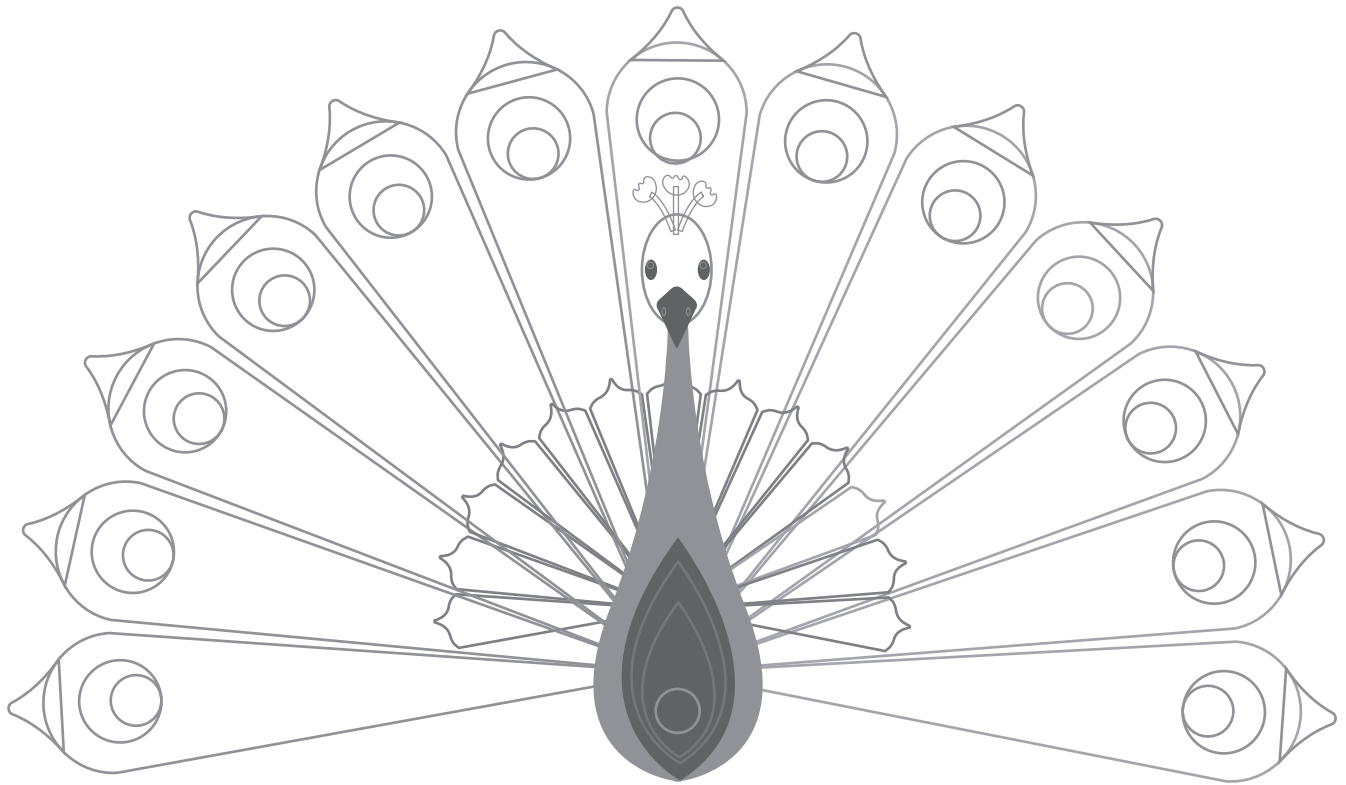
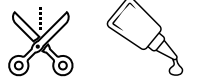

SAFFRON

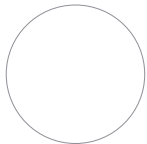

WHITE

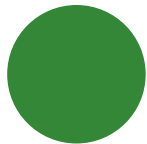

GREEN





# Complete and colour

Complete the picture by joining the dotted lines and colour.  
Make you own Republic Day postcard.

HAPPY  
REPUBLIC  
DAY

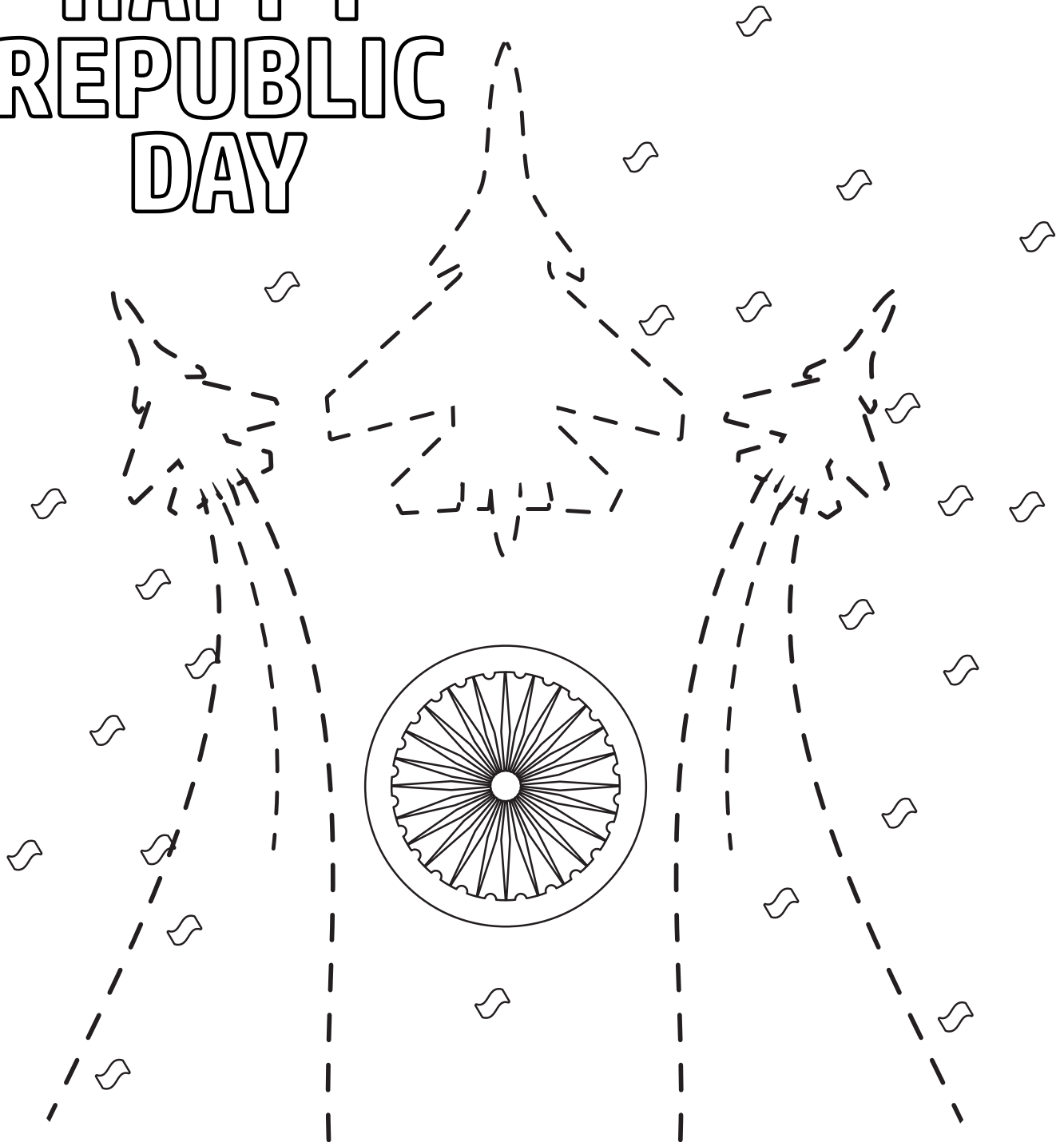

# CATCH THE KITE.

LEVEL: MEDIUM

ESTIMATED TIME: 30 MINUTES

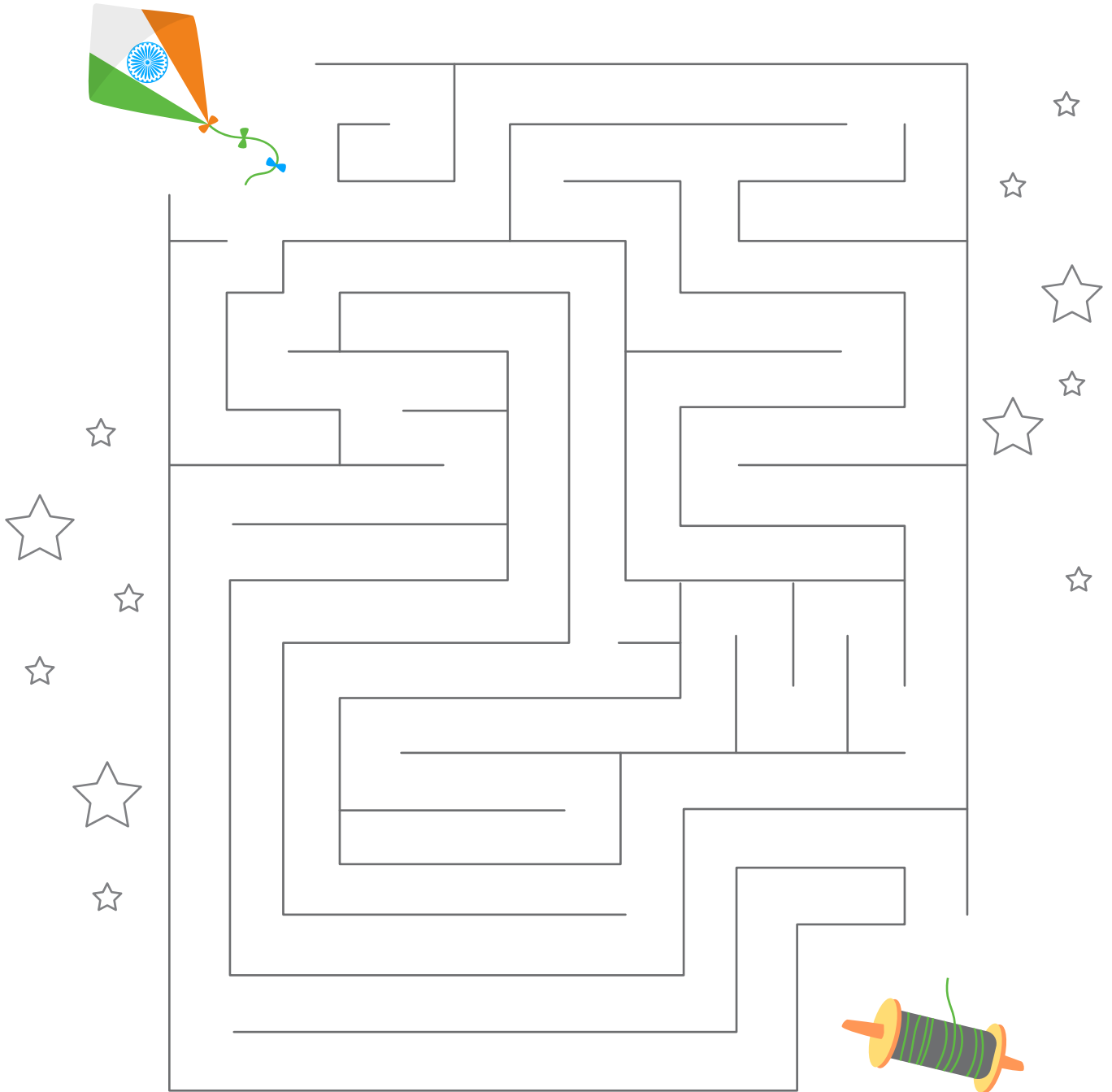
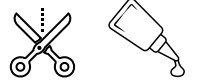

# COLOR

LEVEL: MEDIUM

ESTIMATED TIME: 30 MINUTES

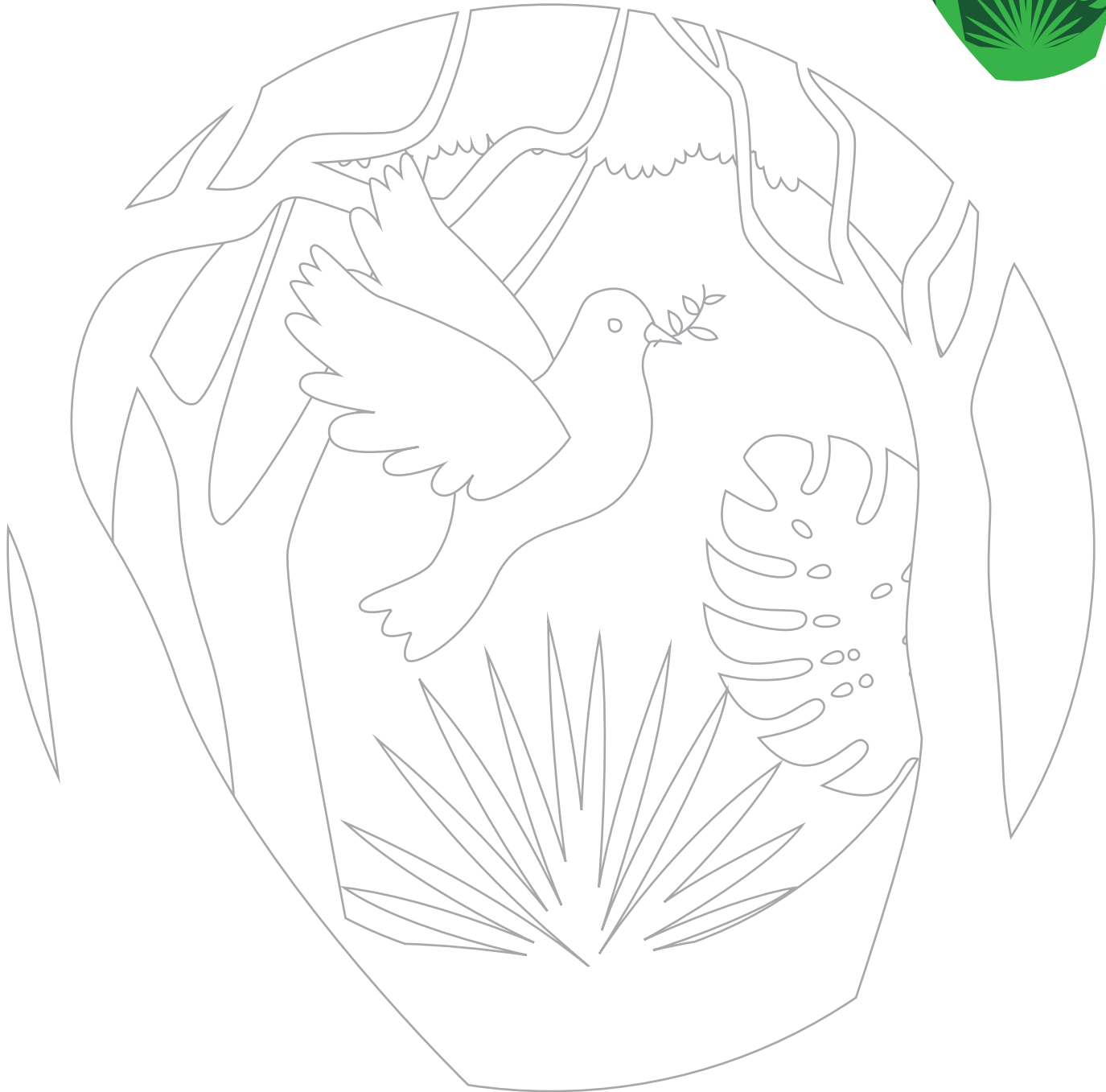



# Republic Day Photo frame



## Instructions

Step 1:  
Print and cut along the solid black line.

Step 2:  
Paste the folds as shown below and place your picture in your photo frame.



# FIND THE WORDS & COLOR THEM

LEVEL: MEDIUM

ESTIMATED TIME: 20 MINUTES



R	H	K	K	R	R	E	X
G	E	L	D	N	R	D	M
C	A	P	H	P	E	A	E
A	D	J	U	R	P	R	D
R	F	B	Q	B	T	A	A
H	O	W	T	K	L	P	Y
I	N	D	I	A	N	I	X
R	A	J	Z	P	H	F	C

● REPUBLIC

● PARADE

● DAY

● INDIAN

# HELP THE LOST TABLEAU REACH INDIA GATE

LEVEL: MEDIUM

ESTIMATED TIME: 30 MINUTES

